



# BADGEMAKER

## User Guide

BY SCREENCHECK



## Index

INTRODUCTION	5
GENERAL INFORMATION	6
Specifications	6
Supported Languages	6
Supported Printers and Card Readers	7
Supported Card Printers	7
Supported Card Readers	9
INSTALLATION	10
REGISTRATION	16
BADGEMAKER DESIGN	18
INTERFACE	19
NAVIGATION	20
Window navigation	20
Main Menu	20
Quick Menu	22
Tool Menu	25
Canvas front and back	30
Card Design Menu	31
Preview	31
Card settings	31
Dynamic Fields	32
Element Properties Menu	33
Element Properties	33
Position	36
Style	36
CREATE A CARD	37
New Card design	37
Existing Card Design	38
BadgeMaker Store	39
Card Design from the Store	39
Browse the Store	39
My items	40

BADGEMAKER IDENTITY	41
INTERFACE	42
NAVIGATION	43
Main Menu	43
A. File	43
B. Store	43
C. Edit Menu	44
Quick Menu	45
Project Card Designs	49
Card designs overview	49
CREATING A PROJECT	50
New Project	50
A. Create a New Project	51
B. Create a new BadgeMaker Connect project	57
C. Create copy of an existing Project	63
D. Import Project from Excel	65
E. New Project from BadgeMaker 7 Project	72
F. New Project from IDPro 7 Project	78
OPEN PROJECT	84
IMPORT DATA	85
A. Import Excel or CSV data	86
B. Import BadgeMaker 7 data	89
C. Import IDPro 7 data	92
D. Import XML data	95
IMPORT PHOTOS	98
EXPORT DATA	99
EXPORT PHOTOS	100
PROJECT SETTINGS	101
Detail View	101
Gallery view	102
Biometric settings	103
Card Designs	104
Card designs assignment	105

Project structure	106
Triggers	107
Manage Project	108
<b>RECORD</b>	<b>109</b>
Add a new record	109
<b>LAYOUT CONNECTION TO RECORD</b>	<b>112</b>
<b>BADGEMAKER ENCODE</b>	<b>114</b>
Contactless encoding	114
CCI Editor	114
2.1 Creating a MIFARE Classic Template using the CCI Editor	114
2.2 Creating a MIFARE DESfire template using the CCI Editor	116
2.3 Creating a UHF Gen 2 Template using the CCI Editor	118
CCI Content Data options	119
Encoding with BadgeMaker	122
Stand-alone Encoding with BadgeMaker	124
Stand-alone encoding settings	124
Stand-alone encoding	125
<b>BADGEMAKER CONNECT</b>	<b>127</b>
Setting up BadgeMaker Connect	128
Changes when working with BadgeMaker Connect	132
<b>BADGEMAKER SHARE</b>	<b>134</b>
BadgeMaker Share Server	134
BadgeMaker Share Client	134
Installation	135
<b>DISCLAIMER</b>	<b>141</b>

## Introduction

Welcome and thank you for using BadgeMaker.

BadgeMaker is desktop-based card production software developed to design card layouts, manage, add or import card data, capture photos and signatures and print a card with one click of a button making the card production process quick and easy.

BadgeMaker is a combination of two specific modules that each have their own strength. BadgeMaker Design focuses on creating perfect card layouts and BadgeMaker Identity can handle your data with the ease of well-known spreadsheet software.

As a user you can design different types of ID cards or other layouts. Using a design tool that you understand, but still has all the needed functions to make the best design possible.

BadgeMaker Design can be used for all your design setups.

BadgeMaker Design gives you the basic tools to create a front and back design, with images, photos, drawing tools and dynamic data. You will be able to create a template with placeholders that help determine the layout of dynamic data. For example: where a passport photo should be placed, a signature or the first and last name of person. Designing one template that can be attached to multiple data records in BadgeMaker Identity will have a great impact on your card production.

As a user you can manage data and layouts for different types of ID cards using different types of printers. BadgeMaker Identity gives you the basic tools to import, add and manage data like personal data, passport photos and signatures. This data can then be connected to a card layout and selected for printing. With BadgeMaker, uploading or printing large amounts of data and cards is possible and makes your card production process an even better experience.

Any Windows PC with a network connection can be used to install BadgeMaker. This PC needs to have an internet connection to download the installation link, there is also an option to work with an offline version.

*This manual does not describe the installation of printers or other peripherals like a Camera or Signature Pad. Please refer to the manufacturer's manuals for further information on these devices.*

## General Information

When you or your organization has chosen BadgeMaker for your card design, data management and card production make sure you have the correct hardware to install it on. Decisions need to be made on which Windows PC is needed for installing BadgeMaker and which card printer you would like to be connected.

## Specifications

### Minimum Hardware specifications:

- Processor Intel Pentium Dual core G640 2,8 Ghz or equal
- Memory 2GB
- Free Disk space 4GB
- Graphics 1024 x 768
- Monitor/Mouse/keyboard
- 3 available USB ports (printer/webcam/signature pad)

### Supported Operating Systems:

- Windows 10 (32 bit & 64 bit)
- Windows 11 (64 bit)

### .NET Framework version:

- 4.7.1

### Be aware:

**Not suitable for installation on virtual machines**

### Supported Languages

English, Spanish, French, German, Polish, Portuguese, Turkish, Italian, Russian and Dutch

## Supported Printers and Card Readers

### Supported Card Printers

Support for new printers is added regularly by means of software updates. [Badgemaker supported printers](#)

BRAND	MODEL	SINGLE SIDED	DOUBLE SIDED	BULK	TRUE BLACK	CONTACTLESS	MAGSTRIPE	UV	NOTES
<b>Datacard</b>									
Datacard	SD260	V	X	V	V	X	X	X	
Datacard	SD360	V	V	V	V	V	X	X	Does not print white text elements on dark or black backgrounds.
Datacard	SD460	V	V	V	V	V	X	X	Encoding is supported for MiFare Classic, Desfire not Plus (Dual DE-ABCM)
Datacard	CD800	V	X	V	V	V	X	X	
Datacard	SP35	V	X	V	V	X	X	V	
Datacard	SP55	V	V	V	V	V	V	V	
Datacard	SP75	V	V	V	V	V	V	V	
<b>DNP</b>									
DNP	CX330	V	V	V	V	X	X	X	
DNP	CX D80	V	V	V	V	X	X	X	
DNP	CX7600	V	V	V	V	V	V	X	
<b>Evolis</b>									
Evolis	Primacy	V	V	V	V	V	V	X	
Evolis	Quantum II	V	V	V	V	V	V	X	
<b>Fargo</b>									
Fargo	HDP5000	V	V	V	V	V	X	X	
Fargo	DTC4500	V	V	V	V	V	X	X	
Fargo	DTC4500e	V	V	V	V	V	V	X	
Fargo	HDP6600	V	V	V	V	V	X	X	
<b>IDP</b>									
IDP	Smart50	V	X	V	V	V	V	X	
<b>Javelin</b>									
Javelin	DNA	V	X	X	V	X	X	X	
Javelin	DNAPro	V	V	V	V	V	V	X	
<b>Magicard</b>									
Magicard	Pronto	V	X	X	V	V	V	X	
Magicard	Enduro	V	V	V	V	V	V	X	Default driver installation setting for Black panel is incorrect.
Magicard	RioPRO	V	V	V	V	V	V	X	
Magicard	RioPRO360	V	V	V	V	V	V	X	
Magicard	Ultima	V	V	V	V	V	V	X	
Magicard	Prima4	V	V	V	V	V	V	X	
Magicard	300	V	V	V	V	V	V	X	
Magicard	600	V	V	V	V	V	V	X	

BRAND	MODEL	SINGLE SIDED	DOUBLE SIDED	BULK	TRUE BLACK	CONTACTLESS	MAGSTRIPE	UV	NOTES
<b>Matica</b>									
Matica/XID	XID8300	V	V	V	V	V	V	X	
Matica/XID	XID8600	V	V	V	V	V	V	X	
Matica	MC110	V	V	V	V	V	X	X	
Matica	MC210	V	V	V	V	V	V	X	
Matica	MC310	V	V	V	V	V	V	X	
<b>Nisca</b>									
Nisca	PR-C151	V	V	V	V	V	X	X	
Nisca	PR-C201	V	V	V	V	V	X	X	
<b>Polaroid</b>									
Polaroid	P2500	V	X	X	V	V	V	X	
Polaroid	P3000	V	X	V	V	V	V	X	
Polaroid	P3500	V	X	V	V	X	X	X	
Polaroid	P4000E	V	V	V	V	V	X	V	Does not print white and colored text elements or transparent images.
Polaroid	P4000S+	V	V	V	V	V	V	X	Default driver installation setting for Black panel is incorrect.
Polaroid	P5000	V	V	V	V	V	X	V	Does not print white and colored text elements or transparent images.
Polaroid	P5500	V	V	V	V	V	X	X	Does not print white text elements on dark or black backgrounds.
<b>ScreenCheck</b>									
ScreenCheck	SC2500	V	X	X	V	V	V	X	
ScreenCheck	SC4500	V	V	V	V	V	V	X	Default driver installation setting for Black panel is incorrect.
ScreenCheck	SC6500	V	V	V	V	V	V	X	
ScreenCheck	SC7000	V	V	V	V	V	V	X	
ScreenCheck	SC7600	V	V	V	V	V	V	X	
<b>Zebra</b>									
Zebra	ZXP Series 1	V	X	V	V	X	V	X	
Zebra	ZXP Series 3	V	V	V	V	V	V	X	
Zebra	ZXP Series 7	V	V	V	V	V	V	V	
Zebra	ZXP Series 8	V	V	V	V	V	V	V	
Zebra	ZXP Series 9	V	V	V	V	V	V	V	
Zebra	ZCL10	V	V	V	V	X	X	X	
Zebra	ZC100/150	V	X	V	V	X	X	V	
Zebra	ZC300/350	V	V	V	V	V	V	V	
<b>Dascom</b>									
Dascom	DC-7600	V	V	V	V	V	X	V	



## Supported Card Readers

OCTOBER 2023	HF MIFARE CLASSIC	MIFARE PLUS	MIFARE DESFIRE	ICLASS	LF HITAG2/PROX	UHF GEN2 UHF
<b>DE-ABCM (DUALI)</b>						
DE-ABCM (Duali)	V	X	V	-	-	-
<b>TWN4 (ELATEC)</b>						
- Z2SC / Z6SC apps (Zebra)	V	V	V	V	V*1	X
- M1SC app (Magicard)	V	V	V	X*3	-	-
<b>Elyctis</b>						
Elyctis	V	X	V	-	-	-
<b>Omnikey</b>						
- 5x21	V	V	V	V*2	-	-
- 5x22	V	V	V	V*2	-	-
- 5x27	V	V	V	V*2	V*4	-
<b>SCR/SDI/Identive</b>						
SCR/SDI/Identive	V	V	V	-	-	-
<b>CrazyWriter (SpringCard)</b>						
CrazyWriter (SpringCard)	V	V	V	-	-	-
<b>ThingMagic UHF</b>						
ThingMagic UHF	X	X	X	X	X	V

### Notes:

- \* 1: Proximity card support is limited to CSN and card-number reading only (Prox cards typically contain very little storage space).
- \* 2: Not all Omnikey card-readers support all aspects of iCLASS encoding. Specifically, some readers are unable to update card keys.
- \* 3: iCLASS support is only available with specific reader models and requires Simple Protocol to be enabled. The Magicard Elatec reader model does not support iClass, and their current app does not have Simple Protocol enabled.
- \* 4: Omnikey card-readers do not support all Prox cards. HID and Insala cards are supported as well as HITAG 2.

## Installation

The software installation of BadgeMaker uses a download link at:  
<http://badgemaker.info/downloads>

The link will download the installer that will look like this picture:



Clicking on the installer above will open a pop-up window. This pop-up will ask if you are sure you would like to run the installer. Clicking on the run button will start the BadgeMaker Setup Wizard. The Setup Wizard will guide you through the installation process.

**Step 1.** If you would like to run the installer and setup BadgeMaker on your desktop, click the “Run” button. If you do not want to install BadgeMaker click on the “Cancel” button.

**Step 2.** Click on the “Next” button to continue the installation of BadgeMaker.



**Step 3.** Choose the installation type, you can select to only install BadgeMaker for your own user account or all user accounts. Click on the “Next” button to continue the installation of BadgeMaker.

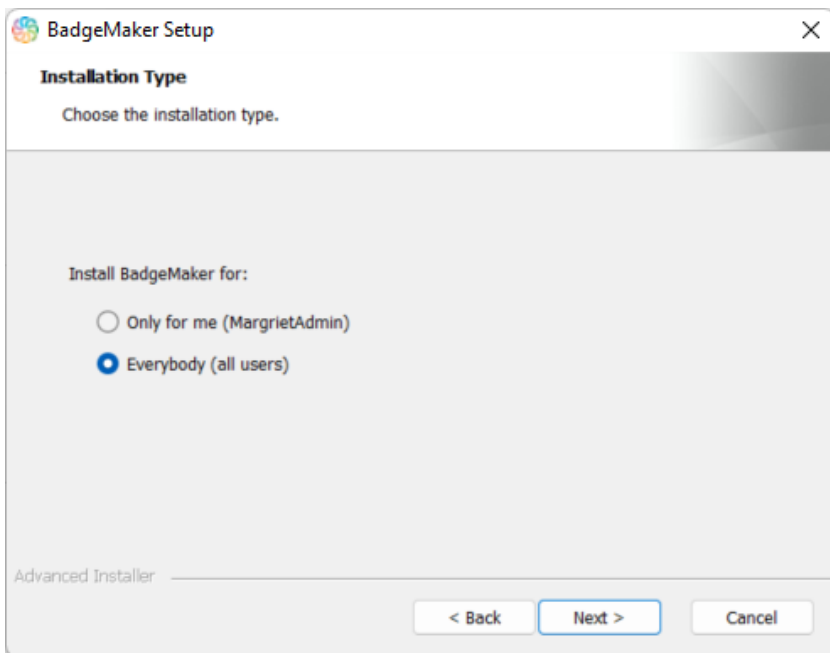

**Step 4a.** The “Features” tab: This step in the installation process is to select how you would like to install BadgeMaker. You can select the features you would like to install. BadgeMaker Design for card design, Identity for creating projects and producing cards, Demo projects, the CCI Editor to create encoding files for smart cards, the BadgeMaker Share server and Microsoft Access are selected by default. If you would like to choose to only install Identity or Design, just deselect the boxes of the features you do not want to install.

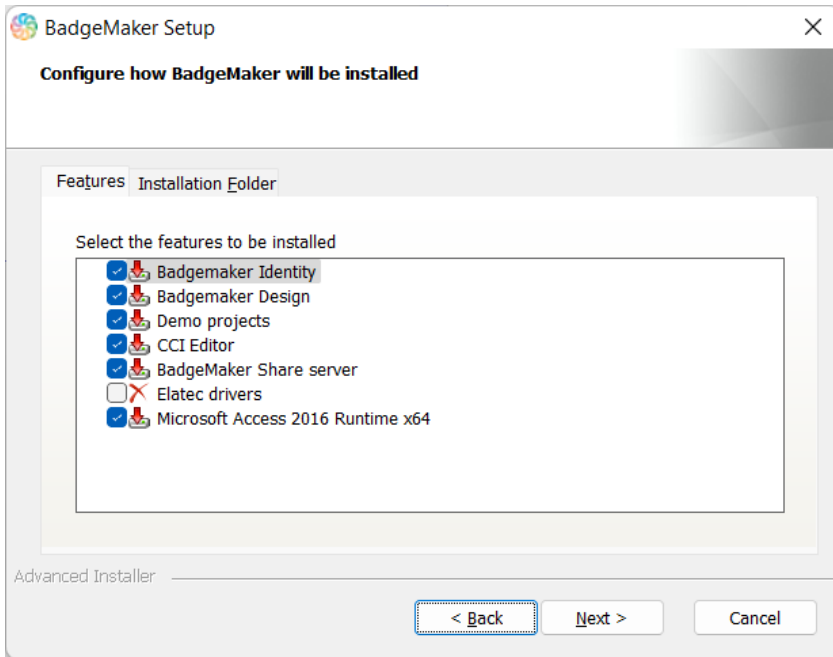

**Step 4b.** The “Installation Folder” tab: The third step in the installation process is selecting where you would like to install BadgeMaker. You can select where you would like to install BadgeMaker by clicking on the browse button and browsing to the needed location. If you do not have a specific location for BadgeMaker you can use the default location.

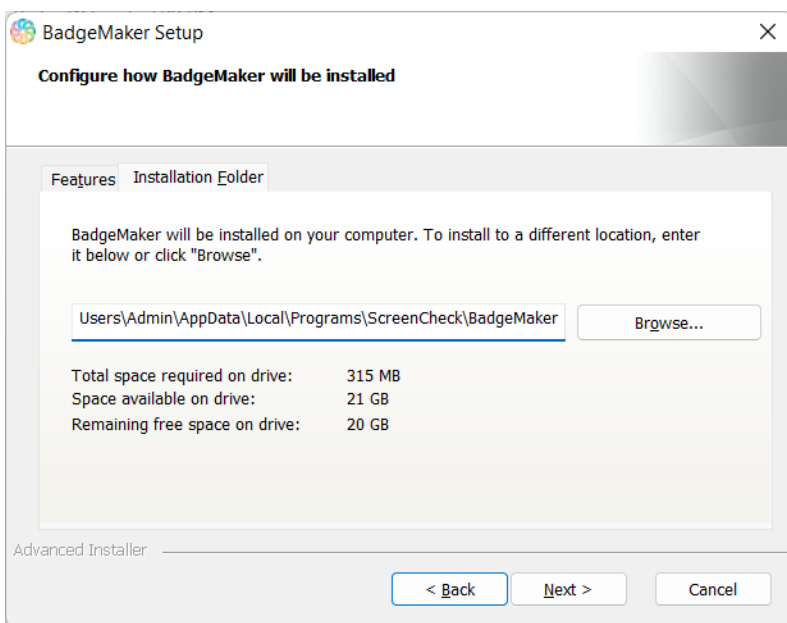

**Step 5.** The Setup Wizard is now ready to begin the BadgeMaker installation. Click the “Install” button to begin the installation. If you want to review or change any of your installation settings, click on the “Back” button. Click “Cancel” to exit the wizard.

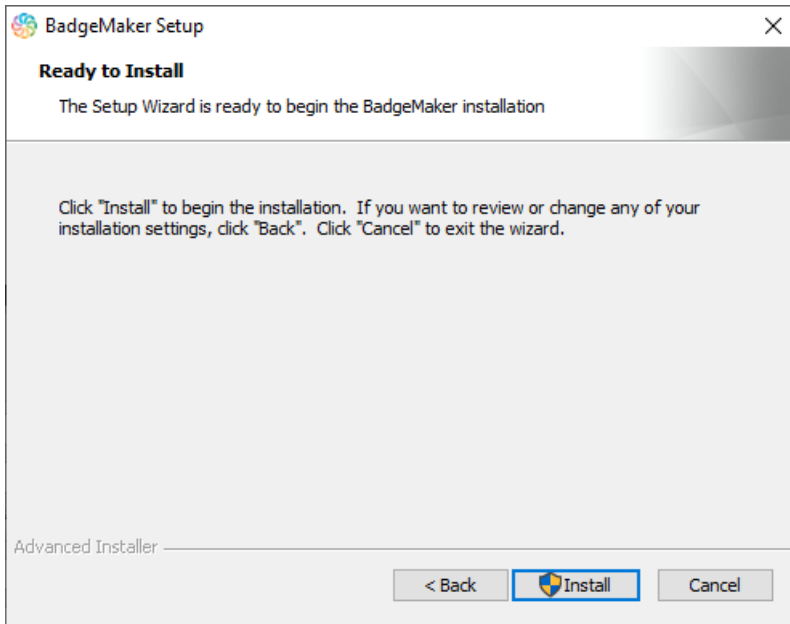

**Step 6.** The installation is now in process. This can take a couple of minutes. A pop-up window will appear to make sure that you want to run the installation.

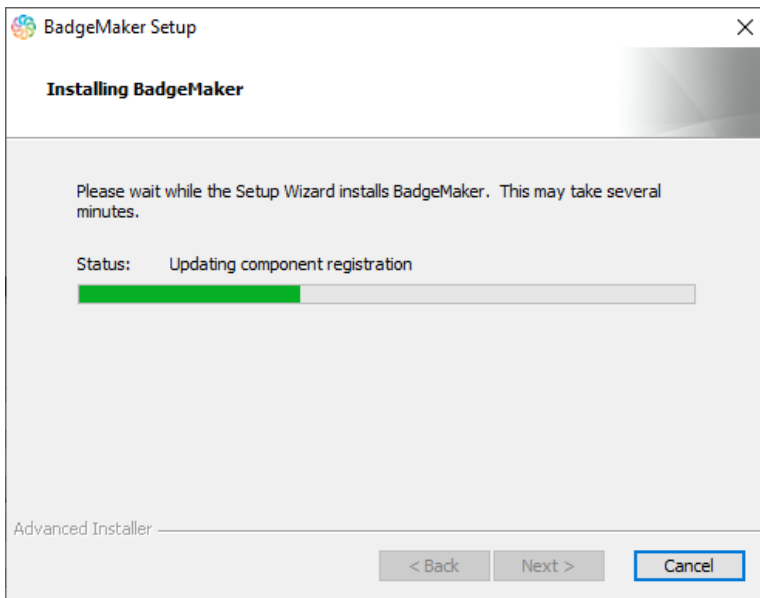

**Step 7.** The installation is complete click the “**Finish**” button to exit the Setup Wizard.

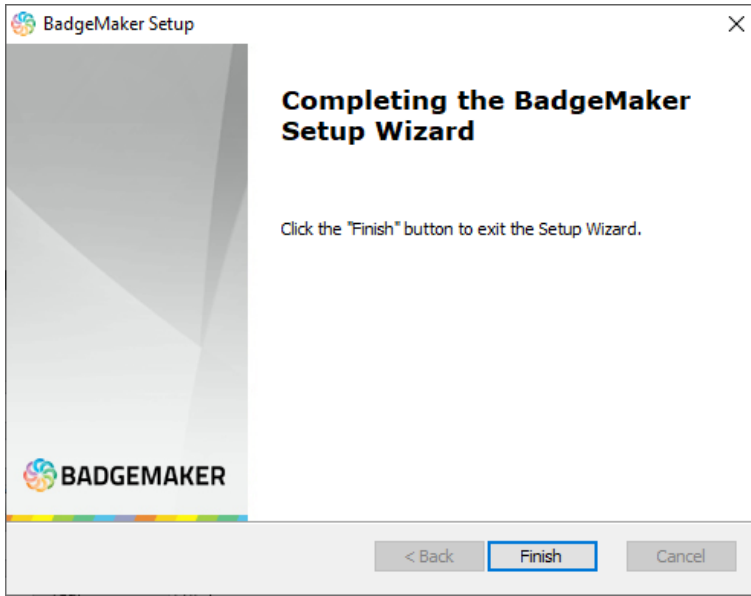

**Step 8.** After completing the installation four shortcut icons will appear on your desktop.



To start with creating a new card layout click on the “**BadgeMaker Design**” icon.



To start with adding card data click on the “**BadgeMaker Identity**” icon.



To start with the setup of the Share Server click on the “**BadgeMaker Share Server**” icon. Be aware that you need a share server license key for the share server to work.



If you would like to create an encoding file click on the “**CCI Editor**” icon.

Before you will be able to start you will need to register first.

## Registration

At the first start-up of BadgeMaker Design or Identity a register window will pop up, so you can register your BadgeMaker.

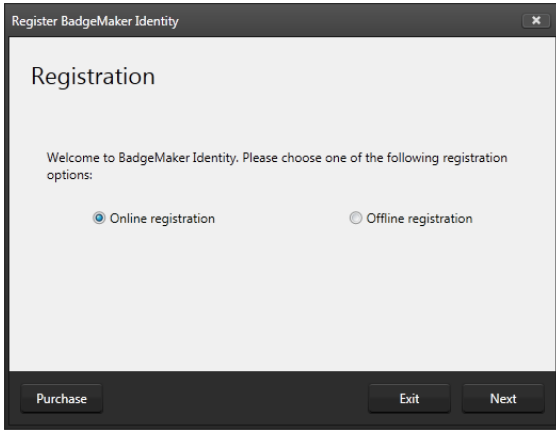

Fig. Example of the BadgeMaker register window.

A. The first question will be about online or offline registration. Select the one that is applicable to the license you bought.

Most of the licenses will be for online registration. No access to the internet to activate your license keys? We offer offline license keys. You can request your local reseller for offline license keys.

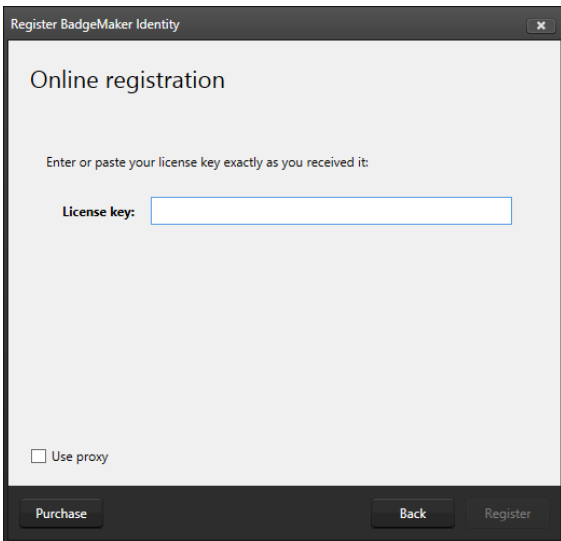

Fig. Example of the BadgeMaker online registration license key window.

### B. Online Registration

You will be requested to enter a License Key. The License key will be provided by our License Manager. Click on the “Purchase” button to get your License Key or visit:

<http://licensemanager.badgemaker.info>

The License Key must be entered (copy-paste) and when the key is valid the software will start. Next time the software will not require the License Key to be entered.

Test keys can have a time restriction and may expire on a given date. (View the License Manager User Guide for more information on License Keys).

Check the “Use Proxy” box and enter the information needed to connect through a Proxy server in your network.

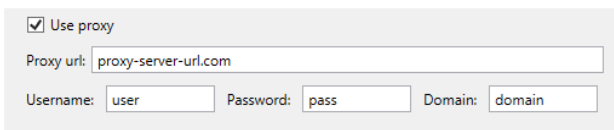



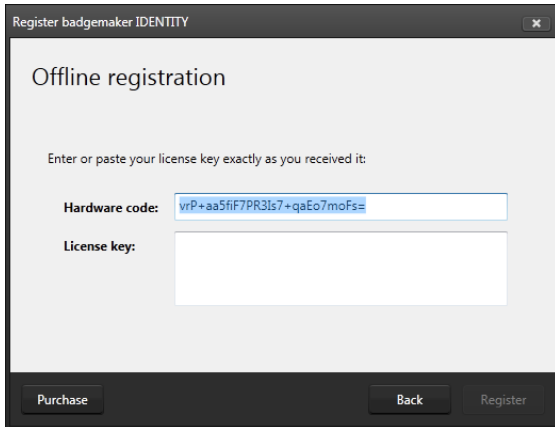

Fig. Example of the BadgeMaker offline registration window.

### C. Offline Registration

You will be requested to enter a License Key. The License key will be provided by our License Manager. Click on the “Purchase” button to get your License Key or visit:

<http://licensemanager.badgemaker.info>

An offline license key requires a hardware code. The BadgeMaker offline key registration window provides this. You can copy and paste it in the requested area in the License Manager. With the use of the Hardware code the License Manager provides an offline license key. The License Key must be entered (copy-paste) and when the key is valid the software will start. Next time the software will not require the License Key to be entered.

*Be aware that an offline key is a one-off key that is only available for the given hardware ID. The offline key cannot be reset!*

Test keys can have a time restriction and may expire on a given date. (View the License Manager User Guide for more information on License Keys).

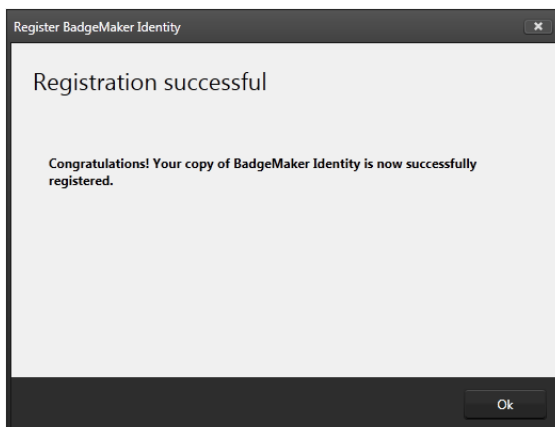

Fig. Example of a successful online registration of BadgeMaker.

When you copy-paste the correct key you will see that the registration is successful. Click the “OK” button to start working with BadgeMaker.



# USER GUIDE

## BADGEMAKER DESIGN

2024 October

User Guide V2.11.12

BadgeMaker Design V2.11.12

# Interface

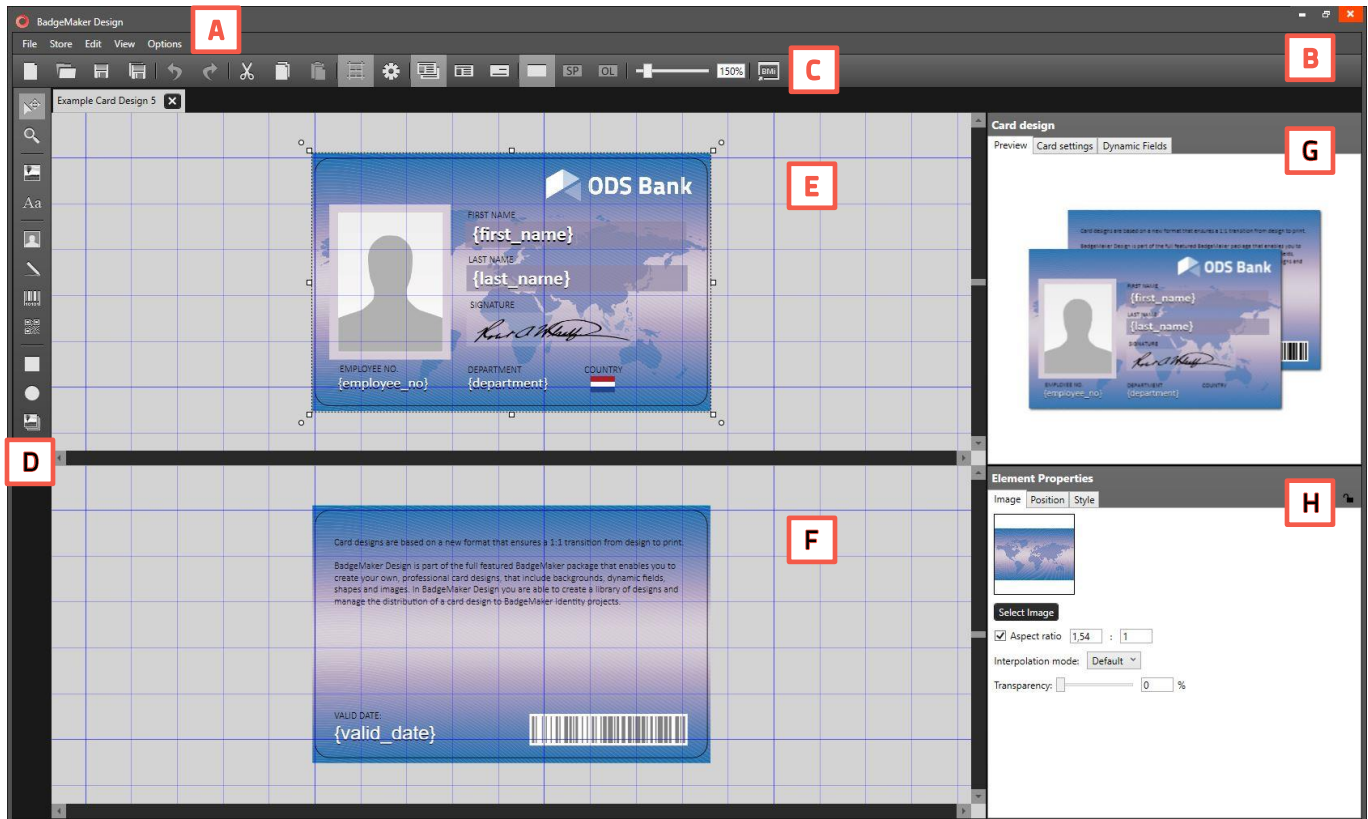

Fig. Badgemaker interface

- A. Main menu
- B. Window menu
- C. Quick menu
- D. Toolbar
- E. Workspace/Canvas Front
- F. Workspace/Canvas Back
- G. Card Design:
  - Preview
  - Card Settings
  - Dynamic Data Fields
- H. Element Properties: Image/Position/Style

## Navigation

BadgeMaker Design makes the elaborate card design process as easy, fast and intuitive as possible. Accommodating the users in your organization that are set with the task of designing your ID-cards. Using a user-friendly overview that shows all the tools and is easy to navigate.

### Window navigation

The window navigation gives the option to **A.** minimize, **B.** maximize or **C.** close.



### Main Menu

The main menu offers the options: “File”, “Store”, “Edit”, “View” and “Help”



The main menu offers the designer 6 sub-menus:

#### A. File Menu

The first button offers the main functions needed to start, use, save and end BadgeMaker Design:

- New Card design:

Create a blank new layout for your ID-card.

- Open Card design:

Open an existing card design that you would like to adjust.

- Import Card design

Import your own BadgeMaker designs.

- Import BadgeCreator design:

Import your old designs created in BadgeCreator.

- Import CardStudio 1.0 design

Import your old designs created in CardStudio 1.0.

- Import IDPro7 design

Import your old designs created in IDPro7.

- Save Card design:

To save a card design click on this link or use the shortcut CTRL + S.

- Save Card design as...:

To save a card design under another name click here. It is also a simple way to create a duplicate of your design.

- Export Card design

Card designs can be exported from BadgeMaker Design as a zip file, ready to send or upload.

- Exit:

This button will let you exit BadgeMaker Design.

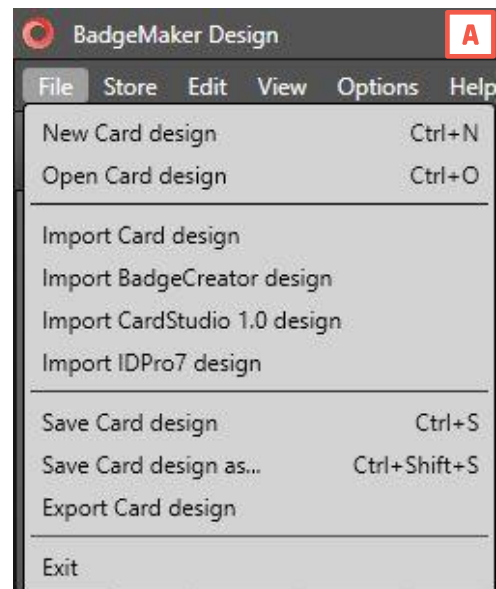

## B. Store Menu

The second button offers the Badgemaker Design Store, you can find different types of example card designs ready to place in “My items” and download. Use the example card designs to get inspired or adjust for own use.

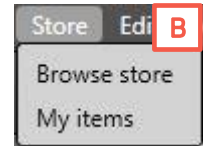

- Browse store: Open the store with a selection of card designs for you to choose from.
- My items: Overview of your selected card designs from the store, ready to download and use.

## C. Edit Menu

The third button will offer all the edit functions that you use during the design process:

### - Undo:

This button will let you undo previous design steps. You can use the short cut CTRL+Z.

### - Redo:

This button will let you redo steps you undid.

### - Cut:

To relocate an object (image, text, placeholder) on the canvas use the cut button. You can use the short cut CTRL + X.

### - Copy:

To copy an object (image, text, placeholder) on the canvas use the copy button. You can use the short cut CTRL + C.

### - Paste:

To paste a copied or cut object (image, text, placeholder) on the canvas use the cut button. You can use the short cut CTRL + V.

### - Bring to Front/bring Forward:

Move elements directly to the front of the design or in steps forward.

### - Send Backward/Send to Back:

Move elements directly to the back of the design or in steps backward.

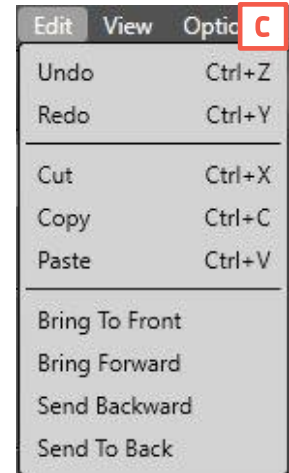

## D. View Menu

The fourth button give you control over the Badgemaker window view, making it able to make these windows visible or invisible:

- Card Design: See the design preview, card settings and the dynamic fields.

- Properties: See element properties. Adjust the different type of elements by clicking on an element and using the Element Properties to make changes.

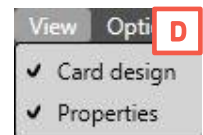

## E. Options Menu

The Options button offers grid settings, language selection and the card design save location path. The Improvement Program allows users to anonymously participate in the optimization of the quality of BadgeMaker.

- Settings: Change BadgeMaker Design settings like enabling the grid, set the type of measurement changing the language or the path to save card designs to.
- Improvement Program: Help optimize the quality of BadgeMaker, by participating anonymously in the Improvement Program.

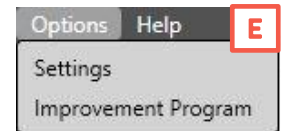

## F. Help Menu

The Help button offers information about BadgeMaker Design, the version, the license and the Help user guide.

- View Help
- View changelog
- License Information
- About BadgeMaker Design

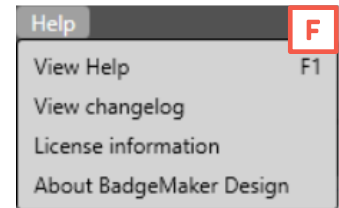

## Quick Menu

The Quick Menu offers the buttons users use most frequently directly clickable. Making main navigation fast.

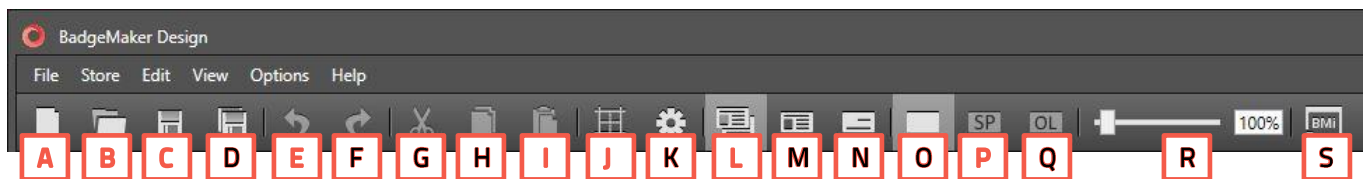

## A. Create new Card Design

Click on this button to start a new Card design.

## B. Open existing Card Design

Click on this button to open an existing Card design.

## C. Save

It is important to save your layout while designing. Click this button to save quickly.

## D. Save as

If you want to save your design under another name, click this button.

## E. Undo

This button gives you the option to undo design steps you made.

## F. Redo

This button gives you the option to redo design steps you made.

## G. Cut

Use the cut icon to replace an element from the back of the layout to for example the front of the layout. Just select the element and click on the cut icon in the Quick menu. Click on the paste icon to place it at its new location.

## H. Copy

To copy elements, click on the element, then click on the copy icon. The element is now ready to be pasted anywhere on the front or back design canvas.

## I. Paste

If an element is cut or copied use the paste icon to place/paste it on the front or the back of the layout.

## J. Show/hide grid

This button will make the grid visible or invisible.

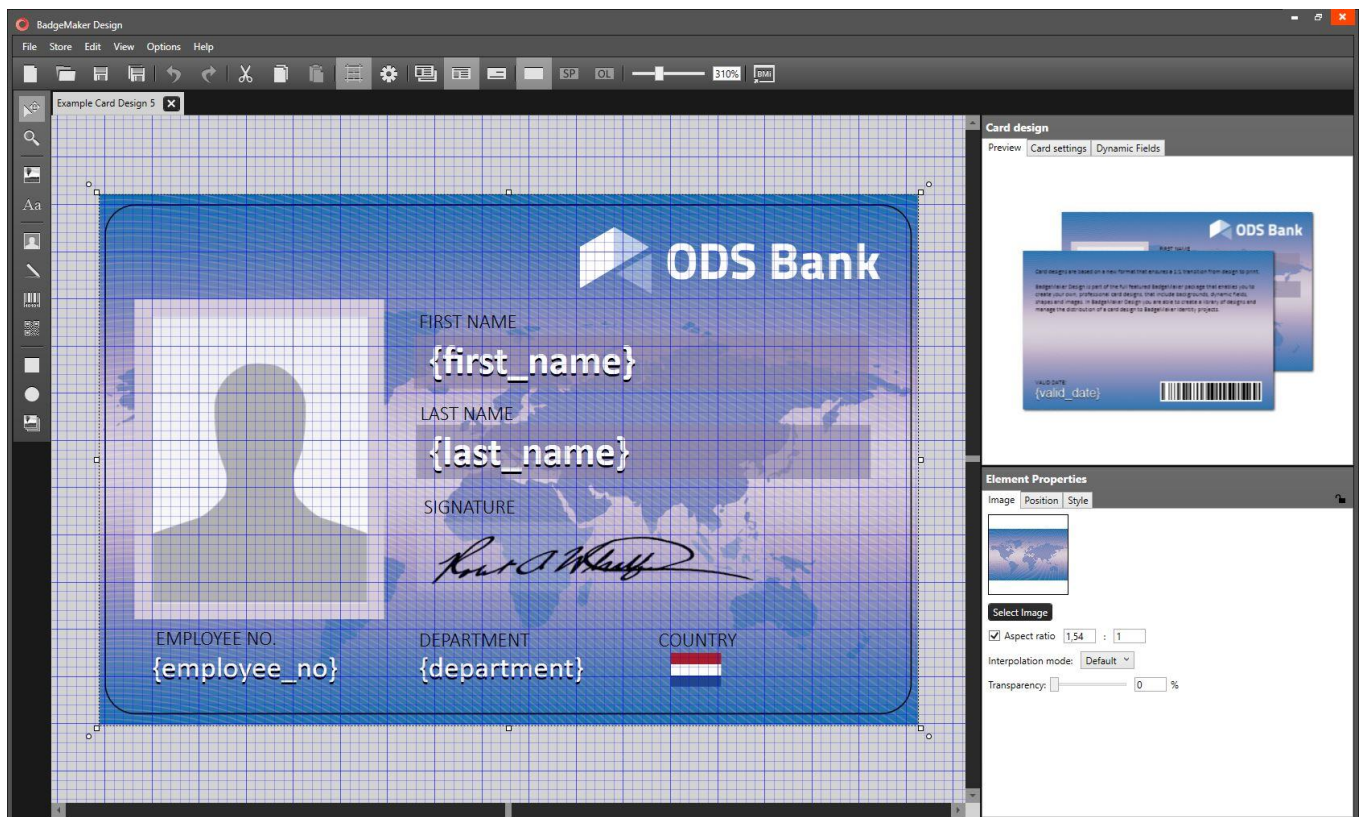

## K. Settings

The open settings button gives you a couple of options:

1. You can check or uncheck the enable grid checkbox to enable or disable the grid.
2. You can choose to snap to grid.
3. You can determine the scale of the grid.
4. You can set the measurement unit to *mm*, *cm*, or *inch*
5. You can set the font size unit: pt or dip
6. You can set the language used in the designer.

Languages supported: *English, Spanish, German, French, Polish, Portuguese, Turkish, Italian, and Dutch.*

More languages will be supported soon.

7. Determine your own project path, where you would like to open and save your designs.
8. To confirm settings, click “OK”
9. To cancel settings, click “Cancel”
10. To exit settings, click “X”

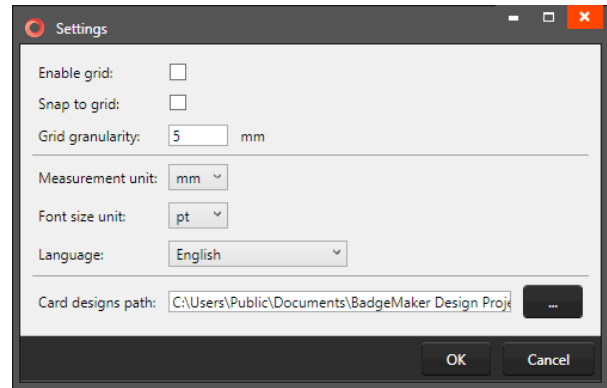

## L. Show front and back designers

Click here if you want to view the canvases for the front and back side of the layout.

## M. Show front design only

Click here if you want to only view the canvas for the front side of the layout.

## N. Show back design only

Click here if you want to only view the canvas for back side of the layout.

## O. Design layer

This is the base layer to work in to design your (YMCK or monochrome) card layout.

## P. Specialty panel

This is a specialty panel to work in when you want your specialty panel (like a pearl panel) to have a certain design or pattern. (Be aware that a specific printer and ribbon are needed to add specific layers with a design or pattern.)

## Q. Overlay panel

This is for the protective overlay panel to work in when you want your overlay panel to have a certain design or pattern. (Be aware that a specific printer and ribbon are needed to add an overlay layer with a design or pattern.)

## R. Scale slider

Use this slider to zoom the canvas view in or out.

## S. PrintStudio

This Quick button lets you open PrintStudio and continue with your card production process.



## Tool Menu



To create and edit a design you need to work with the toolbar setup on the left side. The tool bar offers the following functions:



### A. Select/move tool

This function is used to select an element. This tool also allows you to move an element in the layout. When an element is selected the *move*, icon appears and can be used to move the element.

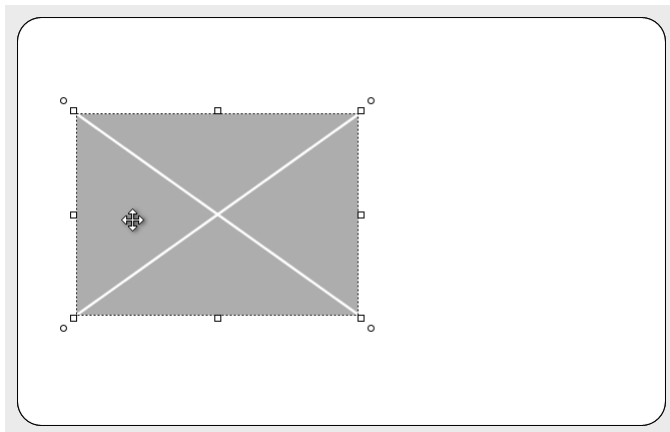



**B. Zoom tool**

The zoom function is enabled and will zoom the layout. At a click of the mouse the zoom is increased one step.

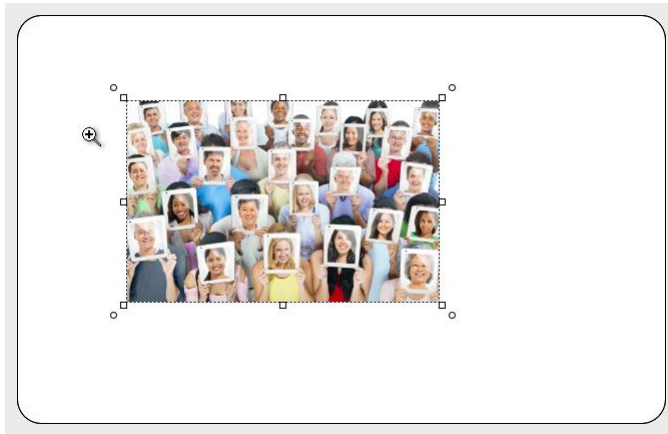

**C. Image tool**

The image element is used to place an image element in the layout.

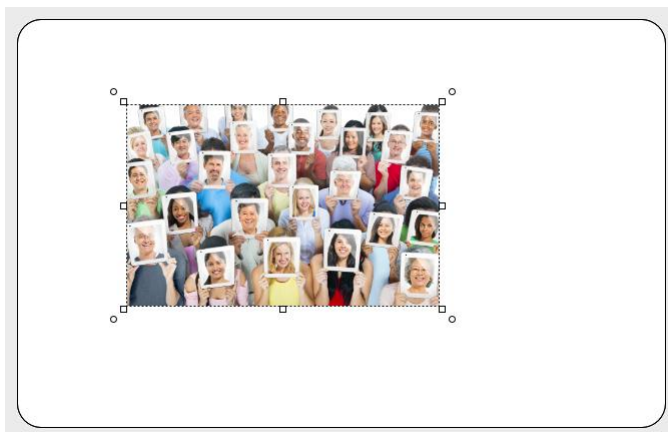

**D. Text tool**

The text element can be used for static and dynamic text. Use the Text Element properties to edit and add text and/or dynamic text to the box. By clicking on the element and going to Element properties you get the text editor.

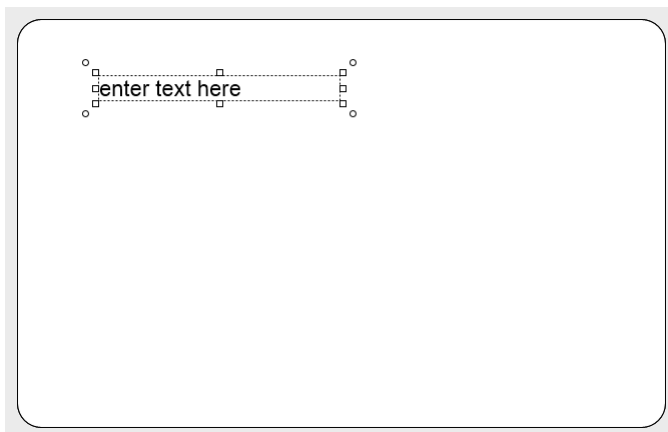



**E. Passport Photo tool**

The Photo element is used to place a placeholder for a passport photo on the layout. You will be able to scale within proportions. When the design is used and connected to data in for example BadgeMaker Identity the placeholder will replace the dummy image with the real passport photo of that person.

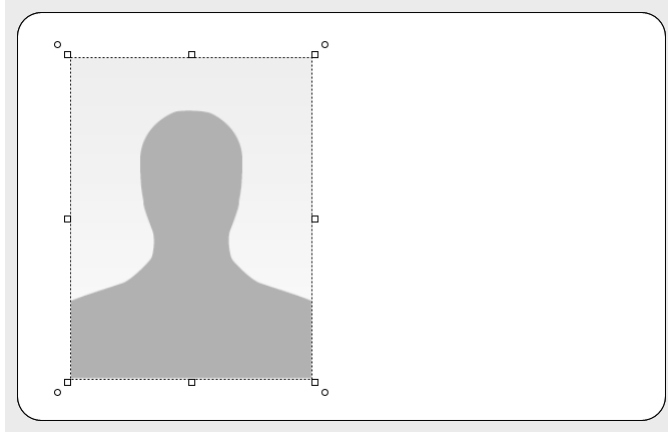

**F. Signature tool**

The Signature element is used to place a placeholder for a signature on the layout. You will be able to scale within proportions. When the design is used and connected to data in for example BadgeMaker Identity the placeholder will replace the dummy image with the real signature of that person.

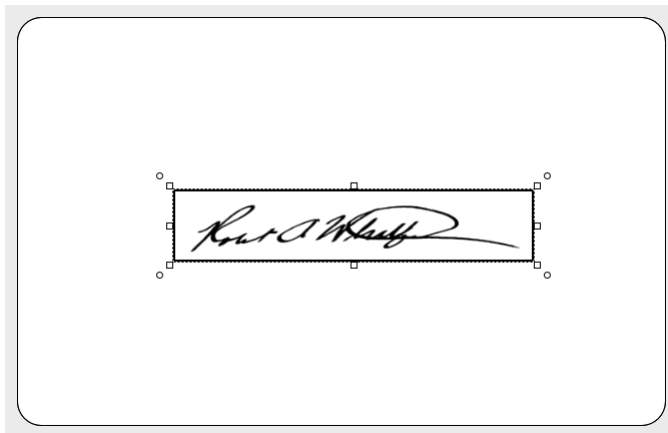



**G. Barcode tool**

The Barcode element is used to place a placeholder for a barcode on the layout. You will be able to scale within proportions. When the design is used and connected to data in BadgeMaker Identity the placeholder will replace the dummy image with the real barcode. There are different types of barcodes available to select in the element properties. Barcodes that are scaled too small might not work. Test your barcode in your design with the needed data before continuing the production process.

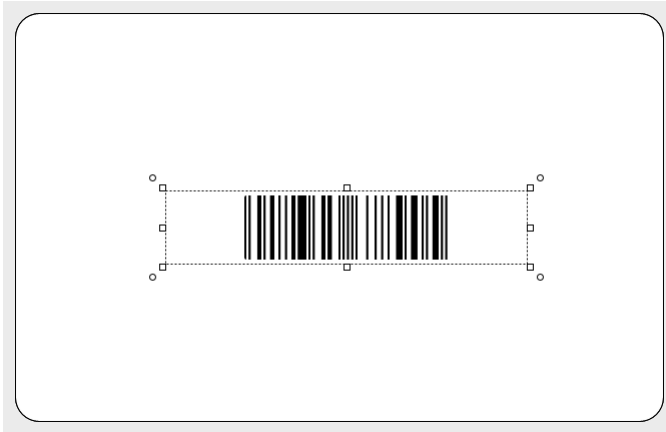

**H. 2D Barcode tool**

The 2D Barcode element is used to place a placeholder for a 2D barcode on the layout. You will be able to scale within proportions. When the design is used and connected to data in BadgeMaker Identity, the placeholder will replace the dummy image with the real 2D barcode. There are different types of 2D barcodes available to select in the element properties.

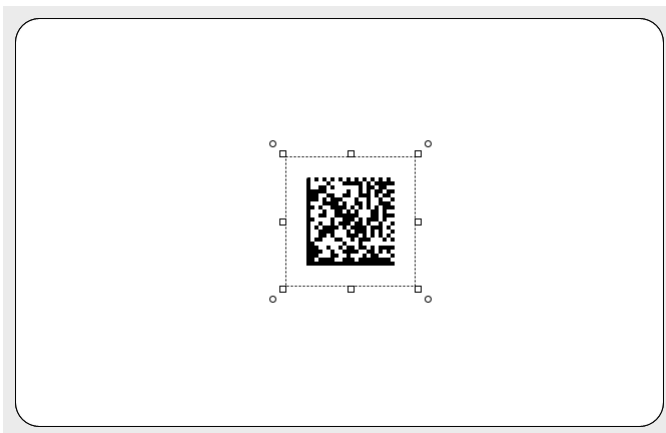



**I. Square tool**

The square element can be used for frames and boxes in the layout.

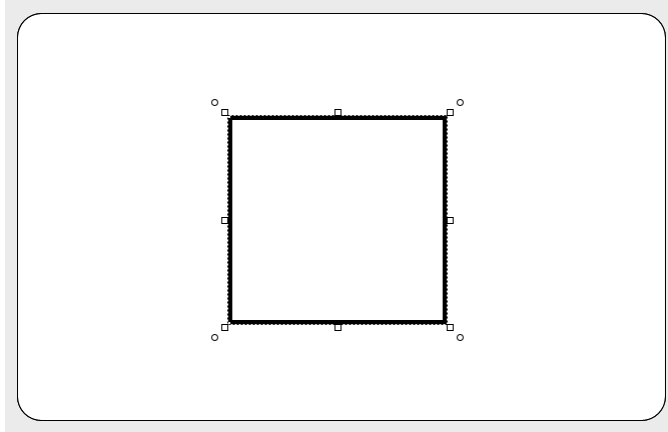

**J. Circle tool**

The circle element is used for elements like circles and ellipsoids.

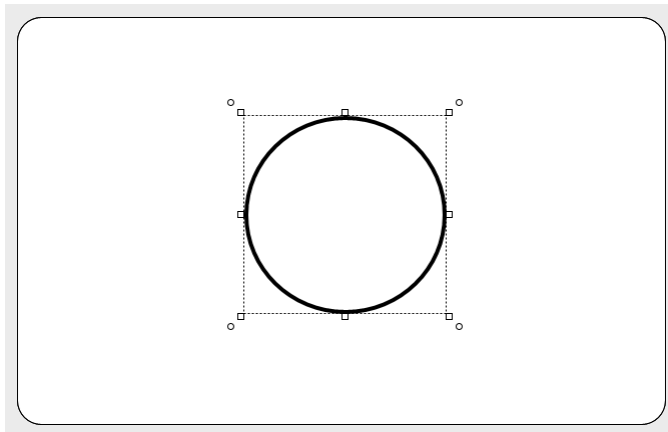

**K. Dynamic logo tool**

The Dynamic logo element is used to place a placeholder for a dynamic logo. The element can scale within proportions. Link your data from an Identity project to specific logo images with the dynamic logo. Depending on the data, the placeholder will be replaced by one of the dynamic logos.

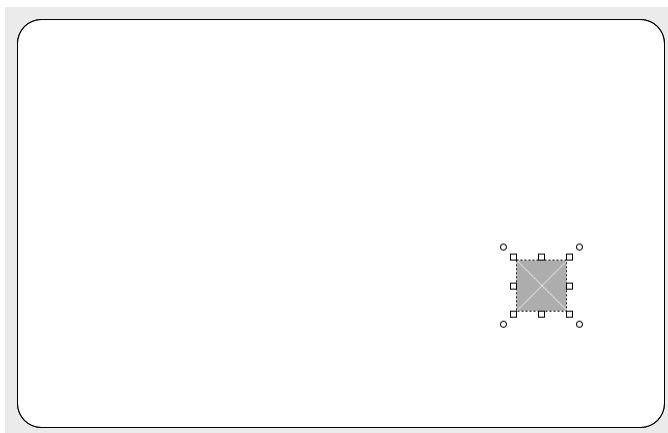

For more explanation on the dynamic logo read [Dynamic logo properties](#).

## Canvas front and back

The front and back canvas can be used to place, edit, move elements. When an element is selected the size of the element can be changed using the arrows/squares at the corners of the elements. The element can also be rotated using the circles at the corner of the elements.

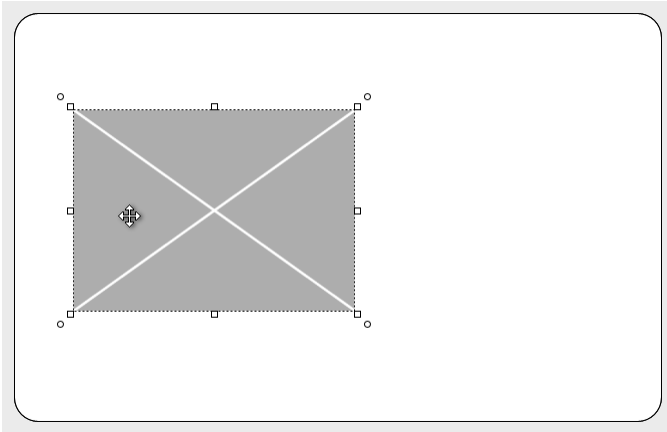

*Fig. Example of an image element placed on the front card canvas.*

Increase / decrease the width or height of an element. The arrow appears when the mouse is hovered to the edge of the element.

The height and width of the element can be changed at the same time. The arrow appears when the mouse is hovered to one of the corners of the element.

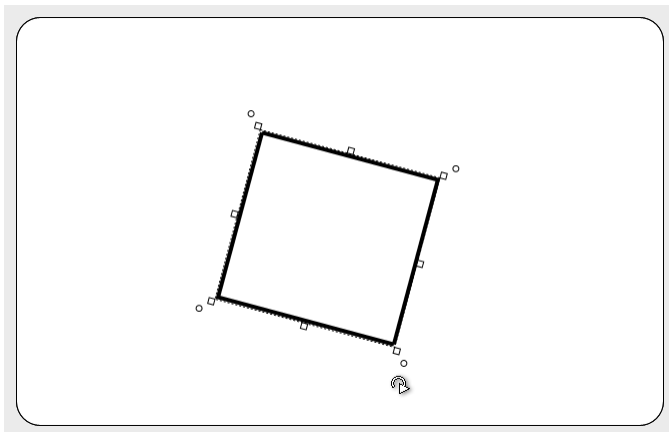

*Fig. Example of a rotated shape element placed on the back-card canvas.*

The orientation of the element can be rotated when the arrow appears. The arrow appears when the mouse is hovered just outside one of the corners of the element.

## Card Design Menu

The Card Design window presents three tabs: **Preview**, **Card Settings** and **Dynamic Fields**.

### Preview

The Preview allows the user a preview of the card design, when clicking on the preview it will toggle front to back.



Fig. Example of the Preview in the Card design menu.

### Card settings

The Card settings tab offers the user information on the Card design properties. It is possible to change or edit the configuration, however the elements already placed are not affected.

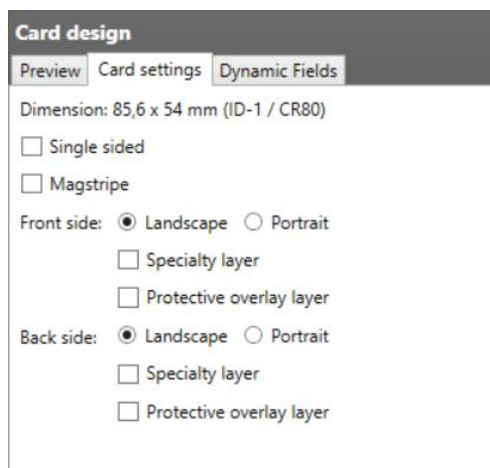

Fig. Example of the Card settings tab in the Card design menu.

## Dynamic Fields

The tab 'Dynamic Fields' will give the user a list of the dynamic fields in the layout. When a text element is created, and the text string has a name in between curly brackets, BadgeMaker Design will detect this as a dynamic field name, and it will be added to the list of dynamic fields automatically.

The user can delete, change, and edit the field names and enter values to be used in preview. It can be tested for long and short names and how they will show up in the preview.

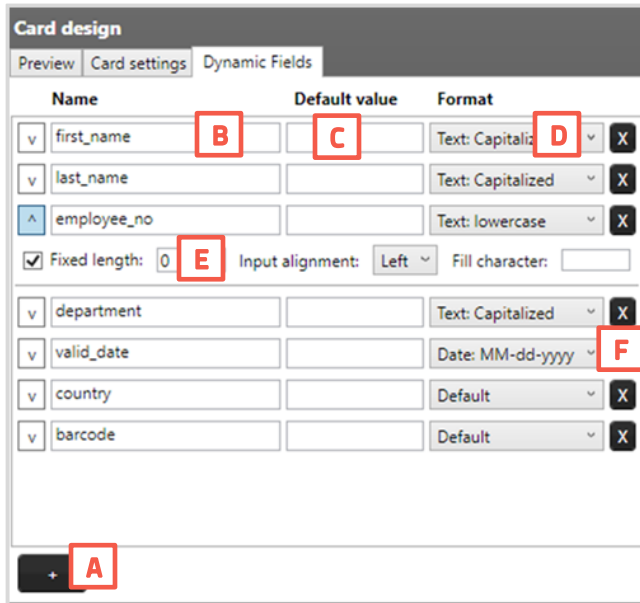

Fig. Example of the Dynamic Fields settings tab in the Card design menu.

- A. Add a new dynamic field to the list by clicking on the “+” button.
- B. List of dynamic fields names. During the setup of a new data field, you will place the data field name that needs to be connected in between the curly brackets as the format name.
- C. Default value of the fields.
- D. Dynamic field format.
- E. It is possible to give dynamic fields a fixed length, input alignment and a fill character. This helps when the dynamic data must be a specific fixed length, for example ID numbers or for specific Magstripe input. Click on the arrow before the dynamic field to open the extra options. The fixed length gives the option to set the number of characters, input alignment allows you to set the input from left or right and fill character lets you fill the empty space with a specific character.
- F. Click on the “X” button to delete a dynamic field.



## Element Properties Menu

The element properties window has three tabs:

**Element edit**, **Element position** tab and **Element style** tab.

Depending on the type of element, this tab will allow the user to view and/or edit the information of the element. When the values are changed, they are reflected immediately in the design; there is no need to hit the enter button. The user can make changes in one window and observe the result in the other window at the same time and vice versa. It depends on the preference of the user to create the layout in a graphical environment or a data element environment.

All elements have the option to lock or unlock an element, to prevent movement.



### Element Properties

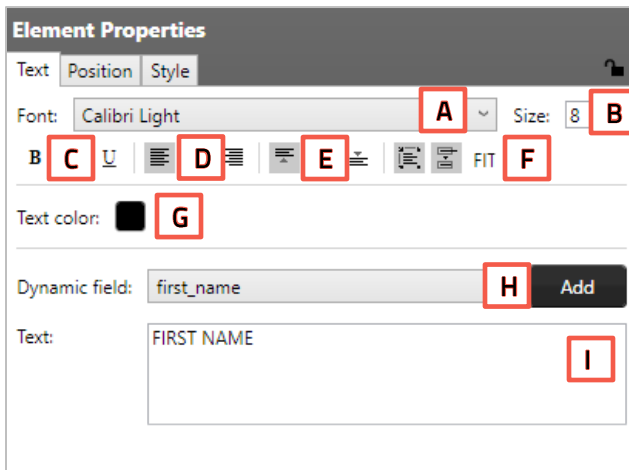

Fig. Example of the Text element properties

#### Text element

- A. Change Font
- B. Change Size
- C. Edit style into **bold**, *italic* and underlined.
- D. Outline the text left, center or right
- E. Align the text to top, center or bottom of the box.
- F. Wrap text automatically, let text be cut of when being too long or set the text to automatically fit the text box.
- G. Give the text color by clicking on the color box.
- H. Choose to add a dynamic field to the text box below by selecting one out of the drop-down menu and clicking on the “Add” button.
- I. Enter all your text here.

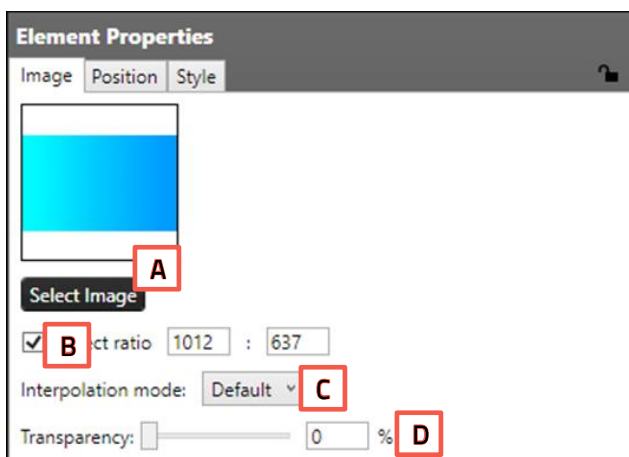

Fig. Example of the Image element properties

#### Image element

- A. Select an image from your computer by clicking on the “Select Image” button.
- B. Choose to bind the ratio.
- C. As a specialty feature you can use the “Interpolation mode” to control image quality during scaling. There are 4 interpolation modes you can choose from:
  - Default
  - Bicubic
  - Bilinear
  - NearestNeighbor
- Keep this setting “Default” when you do not have experience with the interpolation modes.
- D. Use the slider or enter a percentage to change the transparency of the image.

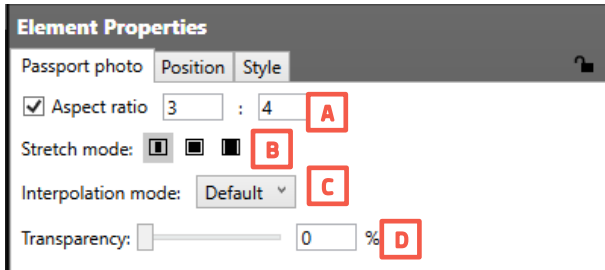

Fig. Example of the Passport Photo element properties

### Passport Photo element

- A. Check box to bind the element to a certain ratio.
- B. Choose one of the 3 stretch options for the image.
  - Fit the image inside the available space, keeping aspect ratio
  - Stretch the image to cover all of the available space.
  - Fill the available space, while keeping the image aspect ratio
- C. As a specialty feature you can use the “**Interpolation mode**” to control image quality during scaling. Choose from: *Default, Bicubic, Bilinear, NearestNeighbor*. Keep this setting “**Default**” when you do not have experience with the interpolation modes.
- D. Use the slider or enter a percentage to change the transparency of the image.

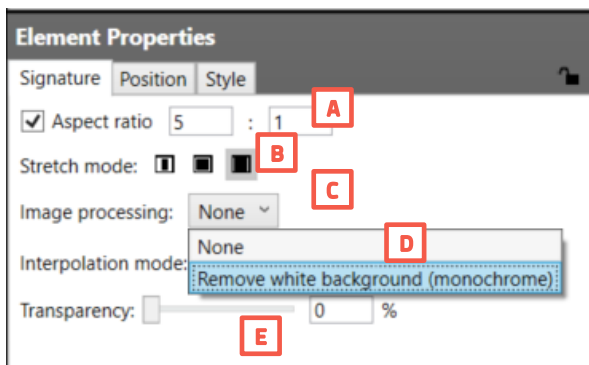

Fig. Example of the Signature element properties

### Signature element

- A. Check box to bind the element to a certain ratio.
- B. Choose one of the 3 stretch options for the image.
  - Fit the image inside the available space, keeping aspect ratio
  - Stretch the image to cover all of the available space.
  - Fill the available space, while keeping the image aspect ratio
- C. The image processing of the signatures gives the option to remove the white background of a signature.
- D. As a specialty feature you can use the “**Interpolation mode**” to control image quality during scaling. Choose from: *Default, Bicubic, Bilinear, NearestNeighbor*. Keep this setting “**Default**” when you do not have experience with the interpolation modes.
- E. Use the slider or enter a percentage to change the transparency of the image.

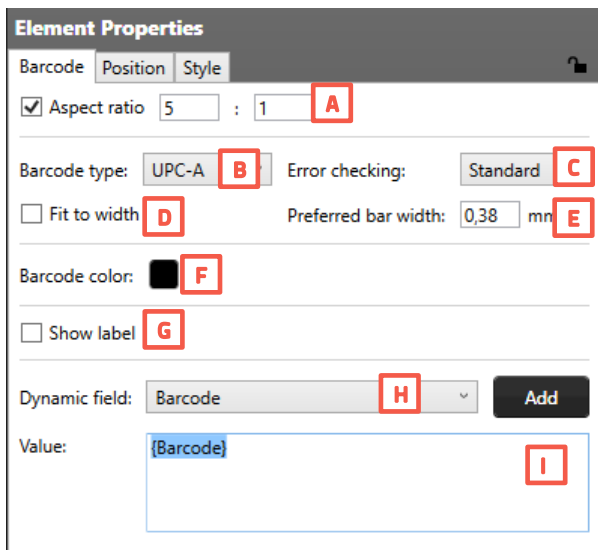

Fig. Example of the barcode setup of element properties.

### Barcode element

- A. Check box to bind the element to a certain ratio.
- B. Choose a barcode type by clicking on the drop-down box and selecting the needed option available.
- C. Select a form of error checking from this list to ensure a correct working barcode.
- D. Fit the barcode to the width of the card.
- E. Manually enter the width of the barcode.
- F. Choose a color for the barcode.
- G. If you want the barcode to show a label with the real data check the show label check box.
- H. Select the dynamic field that you want the barcode to reflect, click the “**Add**” button to add the dynamic field to the value. You can also enter a value for the barcode.
- I. Enter a default value or combine it with a dynamic field.

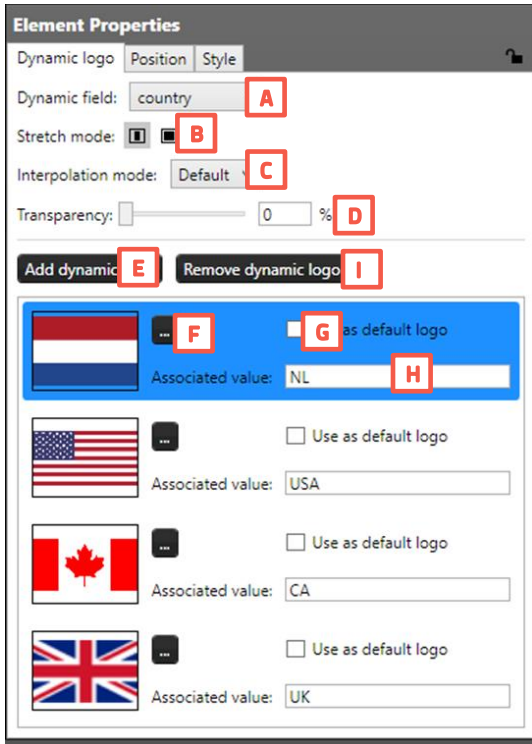

Fig. Example of the dynamic logo setup element properties.

Dynamic logo element

- A. Select the dynamic field that you want the Dynamic logo to reflect.
- B. Select if you want the logo to be the correct ratio or if you want it to fill the whole field.
- C. As a specialty feature you can use the “**Interpolation mode**” to control image quality during scaling. There are 4 interpolation modes you can choose from:
  - a. *Default*
  - b. *Bicubic*
  - c. *Bilinear*
  - d. *NearestNeighbor*
- D. Use the slider or enter a percentage to change the transparency of the image.
- E. Click this button to add a dynamic logo.
- F. Select an image for your dynamic logo by clicking on this button.
- G. Check the default box if you want this image to show up as the default dynamic logo image.
- H. Add the associated value of the dynamic logo.
- I. When you want to delete a dynamic logo select the logo you want to delete first and then click on the “**Remove dynamic logo**” button.

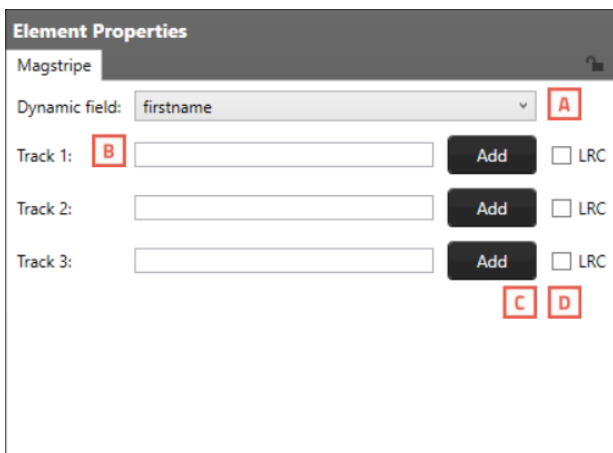

Fig. Example of the MAGstripe setup element properties.

MAGstripe element

- A. Select a field from the drop-down menu that you would like to add as dynamic data to one of the three tracks of the MAGstripe.
- B. MAGstripe allows you to encode three tracks to the card with certain data. The fields will give you feedback when data entered is not correct.
  - Track 1:** Allows you to add 76 characters, A-Z (Capital), 0-9 and certain symbols.
  - Track 2:** Allows you to add 37 numeric characters, 0-9
  - Track 3:** Allows you to add 104 numeric characters, 0-9
- C. Click on this button to add the dynamic field selected in the drop-down menu.
- D. Click the LRC (longitudinal redundancy check) box to add an additional character which helps to validate your data.

**Position**

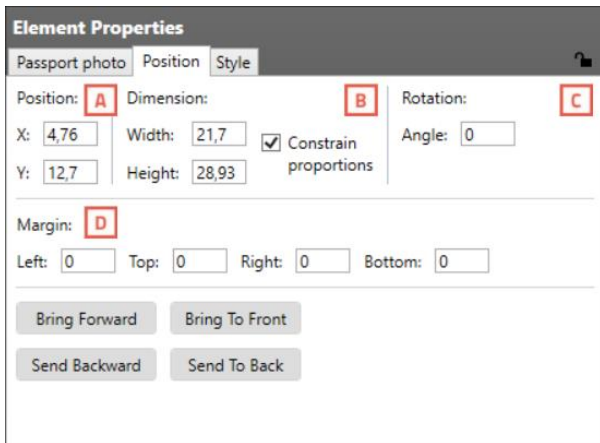

Fig. Example of the position setup of an element.

- A. Determine the position of the used element.
- B. Scale your element giving a width or a height. Check the checkbox to keep the element proportion the same as the original.
- C. Rotate the element by entering an angle number from 0 to 360.
- D. Give your element margins.

**Style**

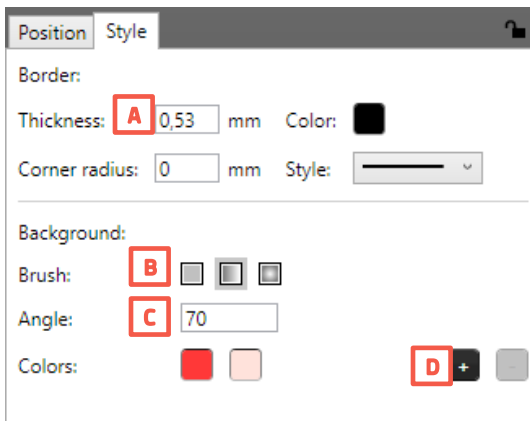
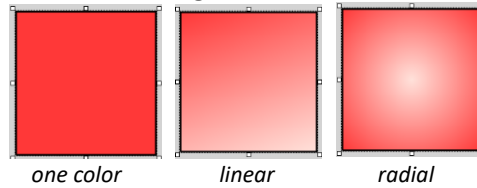

Fig. Example of the style tab with linear gradient selected



Fig. Example of the style tab with radial gradient selected

- A. You can change the thickness of the line, its color, the roundness of the corners (corner radius) or style.
- B. Background color of an element. The background color of an element can be one color or a multicolor gradient color linear or radial.



- C. Set the angle of a linear gradient in degrees.
- D. Add multiple colors to your gradients color by clicking on the "+" button. Click on the color and select a color from the Color window and click on "OK" button to select the color.

Color window

Choose a color for the line or the background using the color window. You can use:

- A. the color picker
- B. RGB sliders
- C. HSV sliders
- D. Add Transparency
- E. Color library using saved colors. To save a color, click the "+" box and select the slot you want to save your color to.
- F. Click on "Ok" when you selected the correct color.

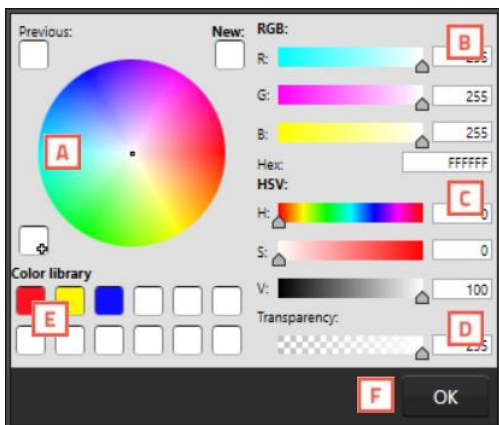

Fig. Example of the Color pop-up menu

## Create a Card

To create a card design you can start a new design or open an existing design.

### New Card design

When clicking on the new card design link or button, a setup window will pop-up.

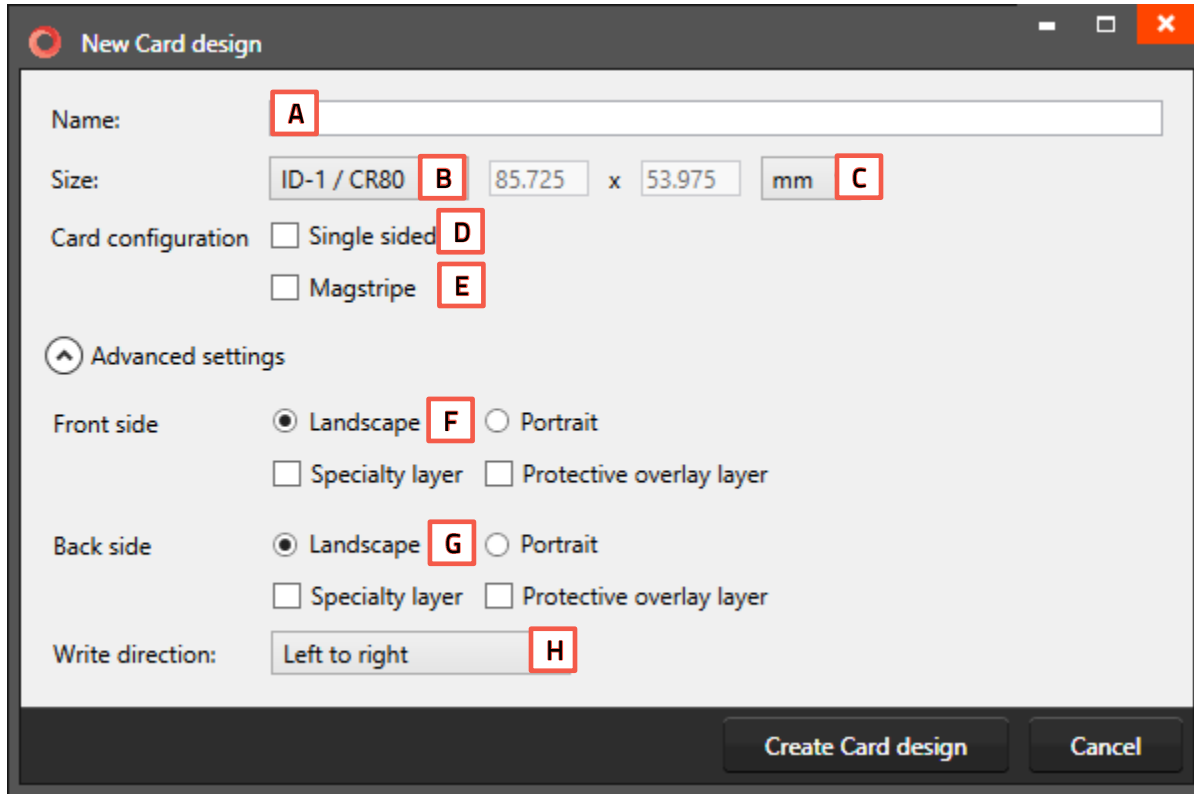

Fig. Example of new card design setup window.

- A. Enter the name for the layout. The exclamation mark at the end appears when the name is not filled out or the name already exists. The 'OK' button is not accessible until a unique name is given.
- B. The size of the Card can be chosen from a drop-down.
- C. Define a custom size for your layout.
- D. Check this box if the design is single sided.
- E. If you want MAGstripe in your design, check this box.
- F. Check the orientation of the design and the use of a design for a specialty layer or protective overlay layer for the front.
- G. Check the orientation of the design and the use of a design for a specialty layer or protective overlay layer for the back.
- H. Set the write direction the text in your card layout from "left to right" or from "right to left".

## Existing Card Design

To open an existing Project, select the open project function. All available existing projects are displayed, and you can select the layout for editing. You can open multiple layouts at the same time.

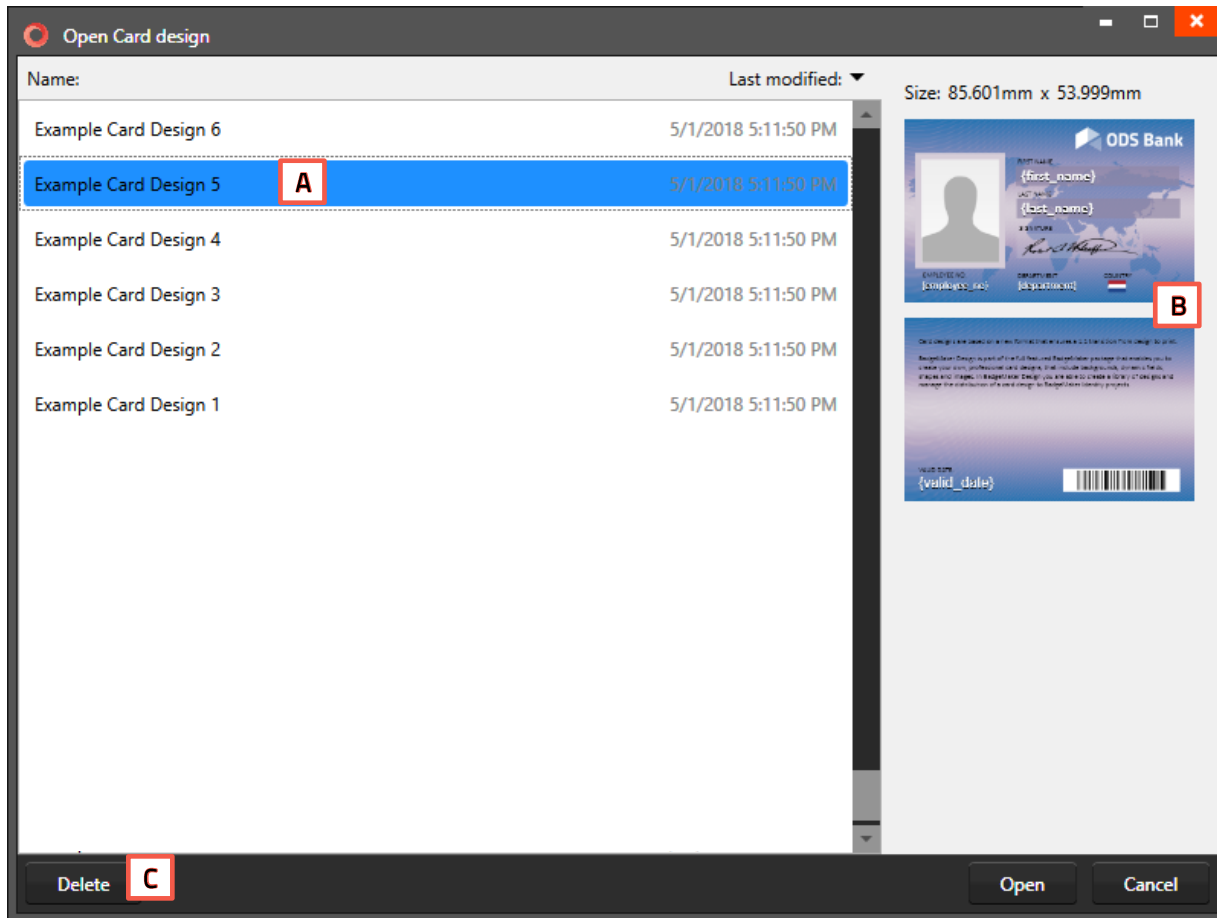

Fig. Example of the Open Card design pop-up window.

- A. Select one of the existing designs.
- B. View the layout of the design selected.  
Check out the properties and the setup of the front and back side.
- C. Delete a selected design.

## BadgeMaker Store

The Store offers free & premium card design templates and projects for you to select, purchase and download.

### Card Design from the Store

Browse the Store to select and download one of the example card design to start with. Get inspired and adjust the example designs to your own liking.

### Browse the Store

To browse the store, go to “Store” in the main menu and click on “Browse store”.

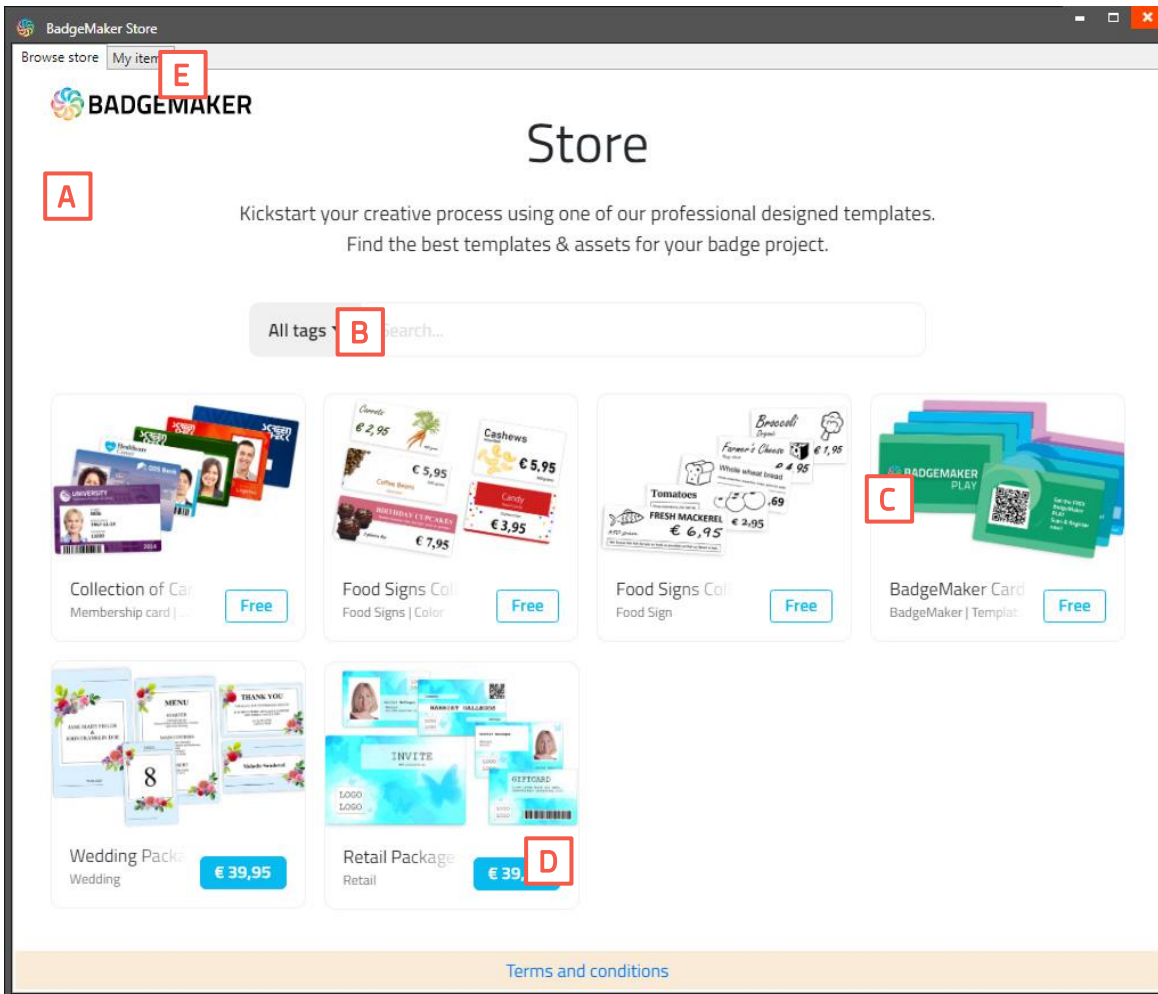
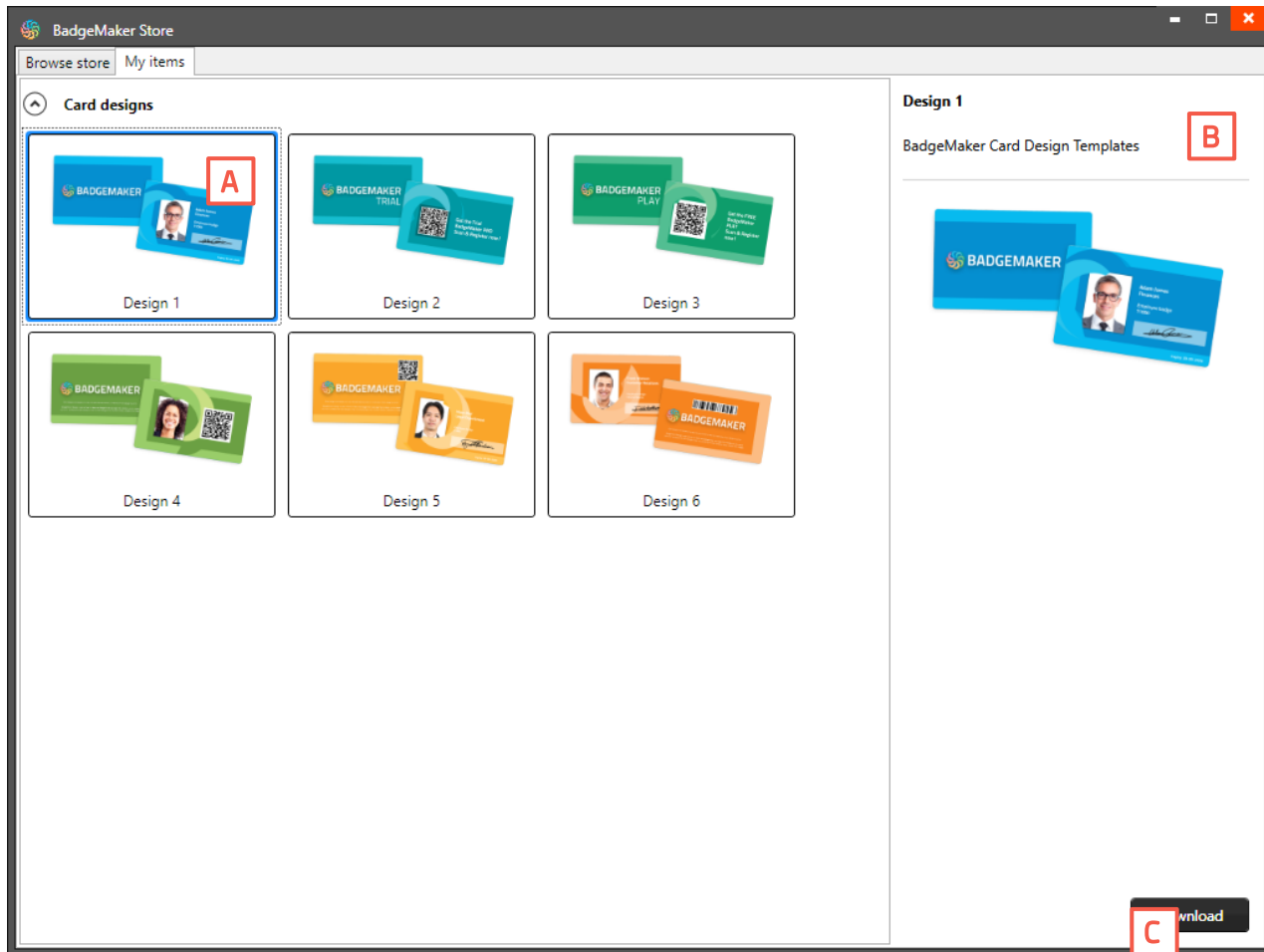

Fig. BadgeMaker Store.

- A. Store: Overview of all the products (card designs and projects) available to select for free or to purchase and add to “My items”.
- B. Filter the overview of card designs by specific tags. Use the drop-down button to select a tag or search card design bundles by name.
- C. Click on the bundle image to learn more about the bundle and its card designs.
- D. Click on the price button to “Add to My items” or “Proceed to Payment” if it is a premium product to add the product to “My Items” and make them available for download.
- E. In Tab “My Items” is where you can find the products like card designs you selected for free or purchased. Select the product to download and use it in CardStudio.

## My items

All the selected card designs added from the Store can be found in the “My items”. These card designs will always be available for you to download.



BadgeMaker Store My Items overview

- A. My items: overview of all the selected card designs from the Store ready to select and download.
- B. Preview images of the selected card design.
- C. Click on “Download” if you would like to download the selected card design to your BadgeMaker Design. Give the downloaded card design a name.

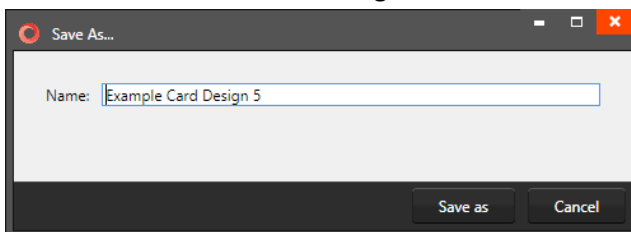

After saving the design is opened automatically in BadgeMaker Design. The card design is now ready to be used.

- D. Click on the “Close” button to close the My items pop-up.





# USER GUIDE

BADGEMAKER IDENTITY

2024 October

User Guide V2.11.12

BadgeMaker Identity V2.11.12

## Interface

The BadgeMaker Identity dashboard offers the following sections:



Fig. Example of the BadgeMaker IDENTITY dashboard overview

- A. Main menu
- B. Window menu
- C. Quick menu
- D. Grid View
- E. Detail View
- F. Photo Slider View
- G. Project card designs overview and preview
- H. Project card design quick menu
- I. Photo and Signature preview

## Navigation

BadgeMaker Identity makes the elaborate card design process as easy, fast and intuitive as possible. Accommodating the users in your organization that are set with the task of managing data and printing cards. Using a user-friendly overview that shows all the tools and is easy to navigate.

### Window navigation

The window navigation gives the option to **A.** minimize, **B.** maximize or **C.** close.



### Main Menu

The main menu offers the options: **File**, **Store**, **Share**, **Edit**, **Record**, **Options**, **View** and **Help**



Which contain 7 submenus, 8 when the BadgeMaker Share Add-On is active:

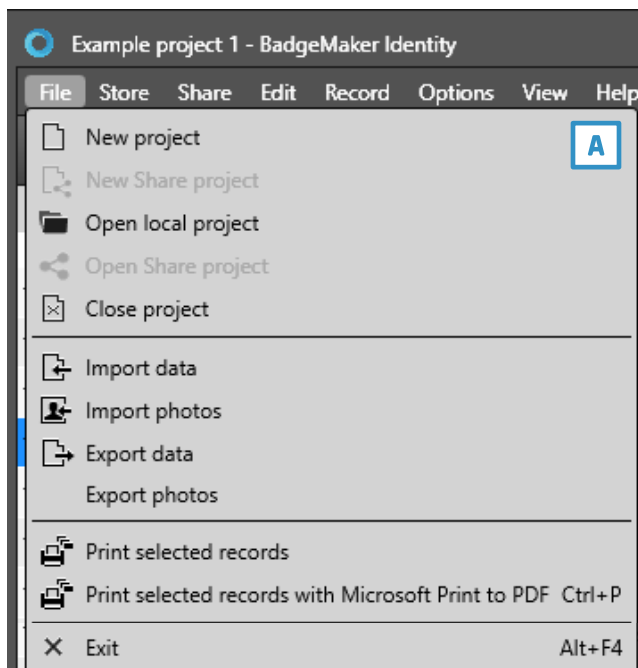

#### A. File

The first button offers the main functions needed to start, use, manage and end a BadgeMaker Identity Project:

**New project:** Start a new project in BadgeMaker Identity

**New Share Project (When Share Add-On is Active)**

**Open local project:** Open an existing project made in BadgeMaker Identity

**Open Share project (When Share Add-On is Active)**

**Close Project:** Close your BadgeMaker Identity Project

**Import Data:** Import data from an Excel file, BadgeMaker 7 or IDPro7 project.

**Import Photo:** Batch import photos or signatures.

**Export project data:** Export the record data to an CSV.

**Export photos:** Export photos from the project.

**Print selected records:** Print the records

**Print with...:** Print quickly with an already set printer.

**Exit:** Exit BadgeMaker Identity

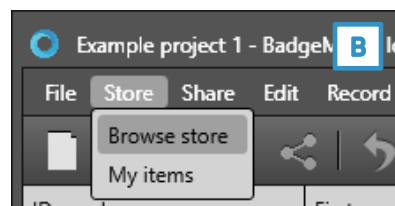

#### B. Store

The Store offers free or premium products like card design templates and example projects ready to place in “My items”. Use the example card designs or projects to get inspired or adjust for own use.

**Browse store:** Open the Store and browse a selection of card designs and projects.

**My items:** Overview of your selected/purchased card designs or projects from the store, ready to download and use.

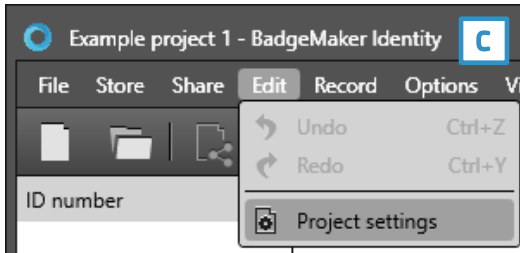

**C. Edit Menu**

The second button offers the edit functions and project settings that you use during the data managing process:  
Undo: Undo recent actions made in your project.  
Redo: Redo actions you undid in your project.  
Project Settings: Change project settings or link card designs to a project.

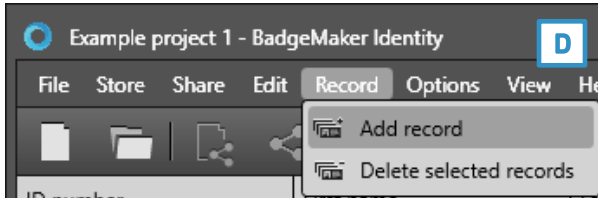

**D. Record Menu**

The third button give you control over the records being able to add new records or delete existing records.  
Add new record  
Delete selected record

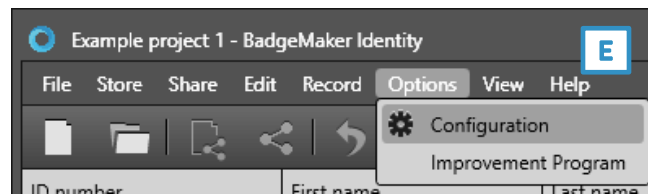

**E. Options Menu**

The Options menu brings you to the configurations of the application like date and language settings.

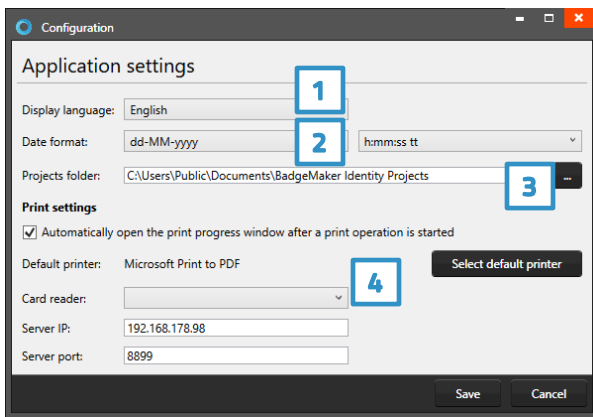

**Configuration:**

1. Configure the language, choose from English, German, Spanish, French, Polish, Portuguese, Turkish and Dutch.
2. Date format, setup the date and time format for your project.
3. Project folder, in what folder you would like to save your projects.
4. Print settings, setup the default printer or card reader.

Improvement Program: Here you can join our Improvement Program. If you join, information will be periodically collected anonymous about how you use BadgeMaker.

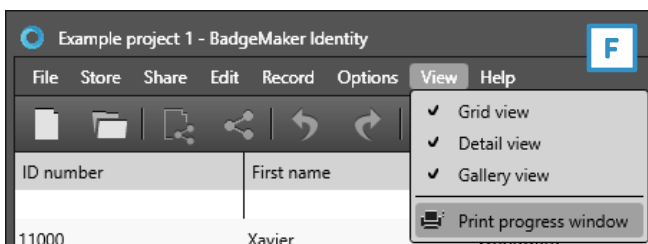

**F. Views menu**

The Views menu makes it possible to make certain views in the main window visible or invisible.

- Grid View
- Detail View
- Photo Slider View
- Print Status Window

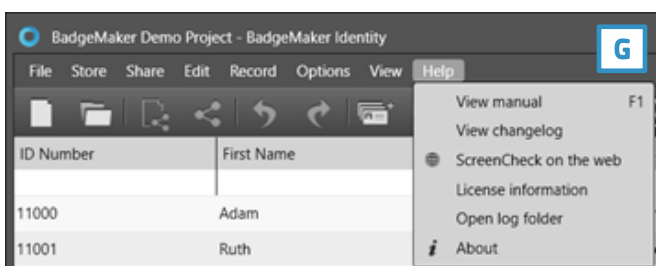

**G. Help menu**

For more information on the application or a user guide click on the Help button.

- View manual (F1)
- View changelog
- ScreenCheck on the web
- License information
- Open log folder
- About

## Quick Menu

When opening Badgemaker a quick menu appears showing two buttons in the middle of the interface, allowing users to continue working with an existing project or creating a new project.

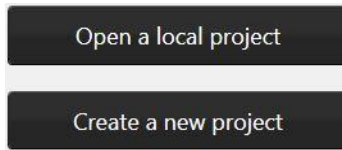

The Quick Menu offers for fast navigation by making the buttons most frequently used directly clickable.



### A. New

Click on this button to start a new Project.

### B. Open existing Project

Click on this button to open an existing project.

### C. Open Share Project

Click on this button to log in to the Badgemaker Share server and work on shared projects.

### D. New Share Project

Click on this button to log in to the Badgemaker Share server and create a new Share project.

### E. Undo

This button gives options to undo processing steps.

### F. Redo

This button gives options to redo processing steps.

### G. Add a new record

This button gives you options to add a new record to the data grid. This means putting in new information, adding a photo and if needed adding a signature.

### H. Delete a selected record

This button allows you to delete a record from the data grid.

## I. Filter records

Have a lot of data in your data grid? This button will be helpful giving you all kinds of different filter options to search for specific groups or a certain person. You can add multiple filter sets. Every filter set can have one or more filter rules. You can combine one or more filter sets to make your search more specific.

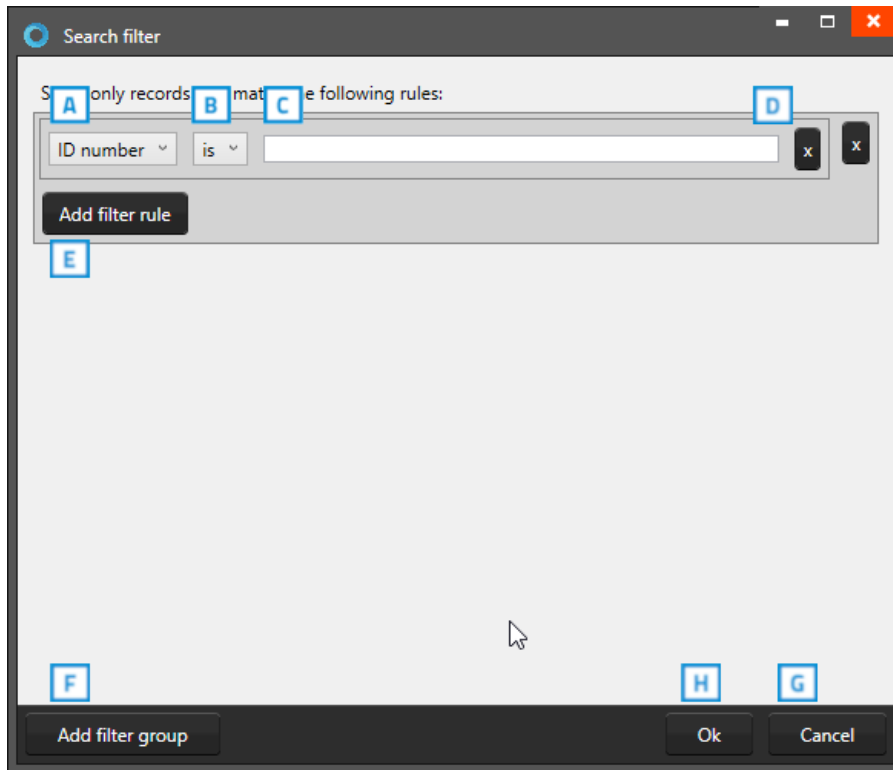

Fig. Example of the filter options window that pop-up after clicking the filter button in the Quick menu.

- A. To set up a filter rule, start with selecting one of the fields that you want to search in. This will narrow a search and make it faster.
- B. After selecting the field, you need to select how specific you want to match the field with the input that you will put into field 3. If the value is very specific choose “is”, if you do not want it to be to specific you can choose “Starts with”
- C. Enter the information you are looking for depending on whether a search is specific or needs to be a group. For example, you could enter a complete index number to find a certain person or just the start of a number.
- D. The “X” buttons are to delete a filter rule, or a filter set.
- E. Click on this button to add a new filter rule to this filter set to narrow your search.
- F. Click on this button when you want to add a new filter set. Example: You use a filter set when searching for two different type of records and need to add a separate search.
- G. Cancel filter option.

To start the search/filter process click on the “Ok” button.

## J. Refresh Data

This button allows you to refresh data when working with BadgeMaker Connect projects making sure all data is up to date with the connected databases.

**K. Print all selected records**

Print all selected records using the most recently used printer and settings.

To print one or more records, select them and click this button to print the records using the most recently used printer and print settings. On first-time use, the printer dialogue will be displayed.

1. A print window pops up, so you can select the printer you installed for the card printing process. This manual does not describe the installation of printers. Please refer to the manufacturer’s manuals for further information on these devices. After selecting the printer, click on the “Print” button.

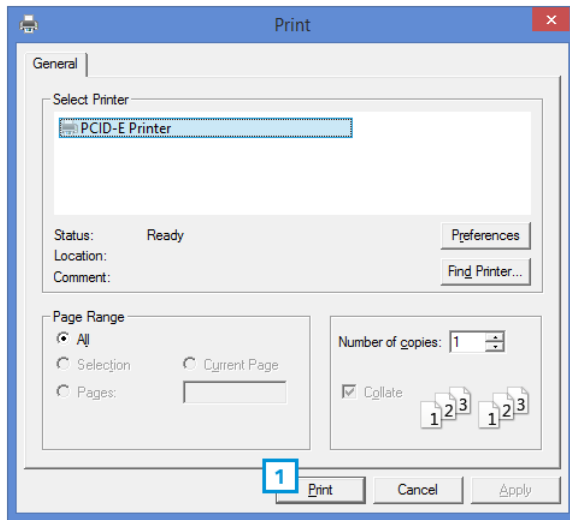

Fig. Example printer setup window.

2. A print progress window will pop-up that will show you the progress of the cards that are being printed.

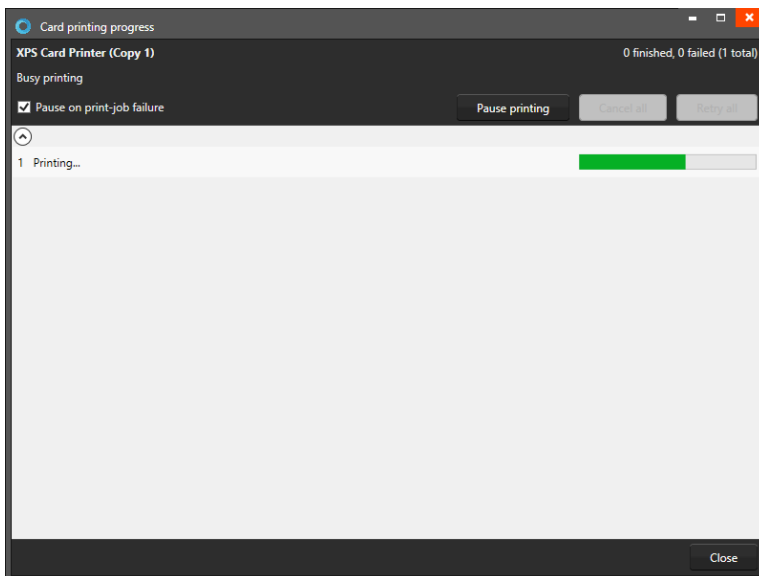
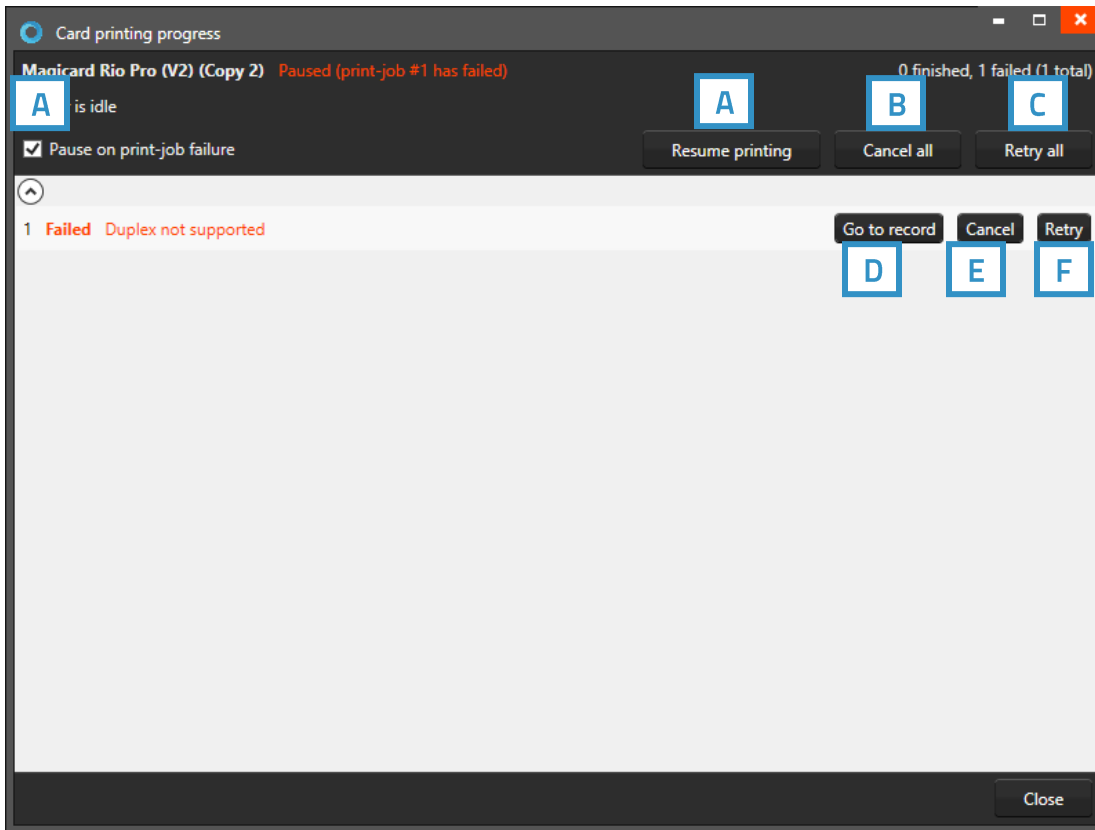

Fig. Example of the Card printing progress window.

3. If a record fails to print, a couple of options are presented:



- A. You can check the box to enable pause on print-job failure, this will pause the printing of the rest of the records you selected for printing when a record has a print error. To resume printing click on the “Resume printing” button.
- B. To cancel all records from printing click the “Cancel all” button.
- C. To retry all records in the print job for printing click on the “Retry all” button.  
For the record that failed a couple of record options are presented:
- D. To check the record data, click on the “Go to record” and the record data appears.
- E. To cancel the failed record, click on the “Cancel” button, the rest of the print job can still be printed if they do not run into the same error.
- F. When you fix the error, you can click on the “Retry” button to try and print the record again.

#### L. BadgeMaker Design

This quick menu button lets you open BadgeMaker Design and continue with creating or adjusting your card design.



## Project Card Designs

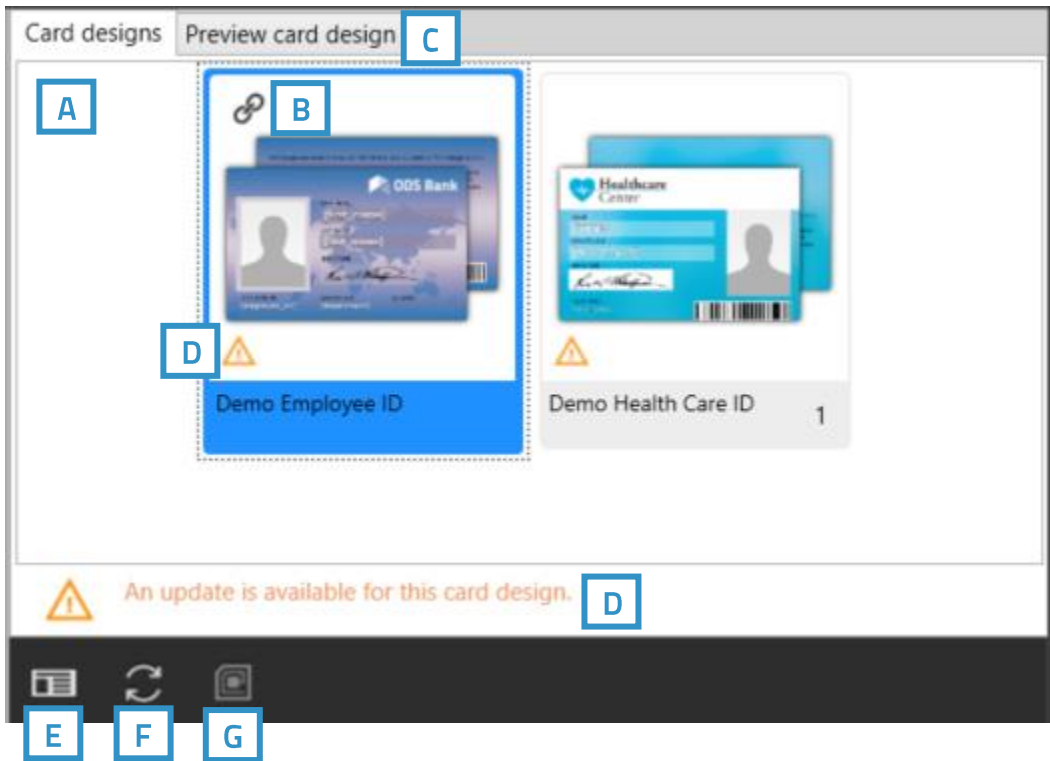

### Card designs overview

- A. The card designs overview shows the designs added to this specific project
- B. The link icon allows you to link one or more selected records to this card design.
- C. Select a record and click on the Preview card design tab to see a preview of the card design linked to the record.
- D. The warning icon lets you know an action is needed for this card design. An action can be that an update is available for the design for example. F. Update a card design using the update icon in the quick menu.
- E. The card design icon gives a quick navigation to the card design settings of the selected card.
- F. Update a card design using the update icon in the quick menu
- G. With the encode icon you can quickly navigate to the encode settings of the selected card. If a card design does not have encoding, the icon will be greyed out.

## Creating a Project

To setup an Identity project you can start by setting up a new project or opening an existing one.

### New Project

When clicking on the “New” link or button a setup window will pop-up. You can select one of the six options to start a new project:

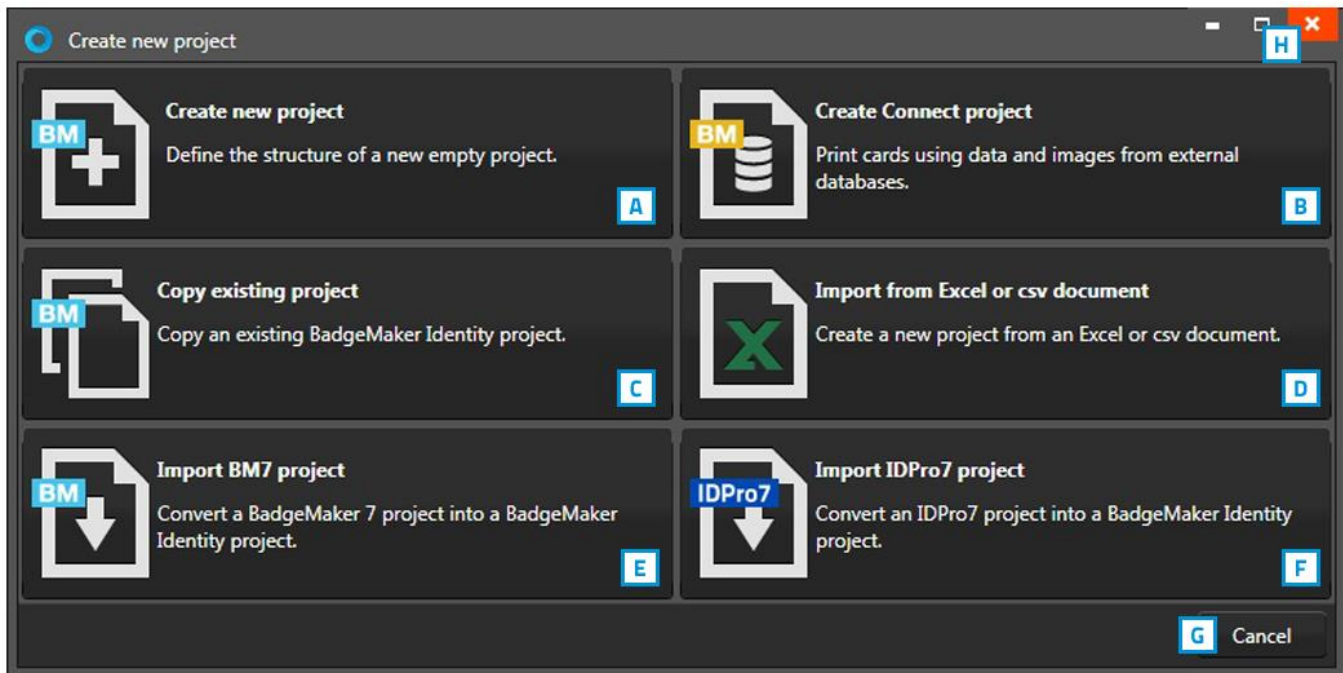

Fig. Example of the Create new project window.

H. Close the pop-up with this button.

G. To cancel a new project, click on the “Cancel” button.

## A. Create a New Project

Click on Create a New Project if you want to start with a blank data grid and setup your own field names.

### 1. Project Structure

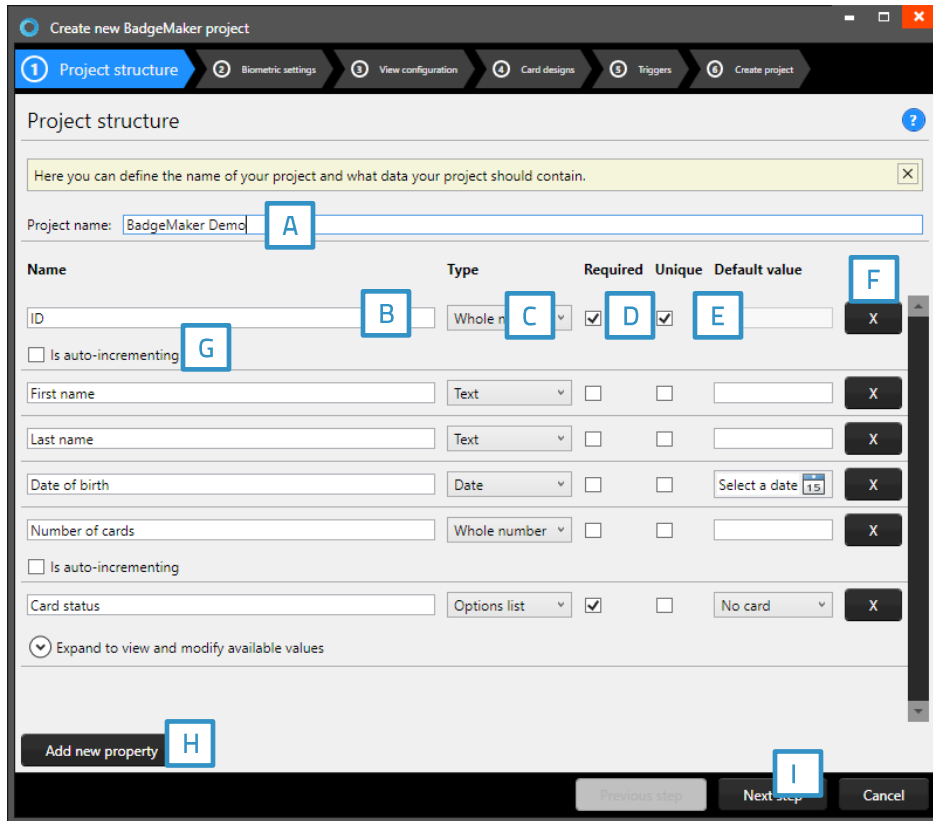

Fig. Example of step 1. New project: add Project data columns

Step 1. Is to setup the project structure by adding the project data fields.

- A. Enter the name for your new project.
- B. Enter the data field name.
- C. Set the data type. Select if the data is numbers or text for example. The following types of database fields are supported:
  - Whole Number, when selecting this type, you can select 'auto-increment'. When a new record is created the number will be the highest number in the project increased by 1.
  - Text
  - Decimal number
  - Option List, when this list type is selected you can add and delete the list values from the list that is presented for this database field.
- D. Check these boxes if the field needs to be "Required" and/or "Unique".
- E. With the default input field, you can add a standard value to your data field. Existing empty fields and new records will automatically display the default value you add to this data field.
- F. Click on the "X" button to delete a data field from the project structure setup.
- G. Enable auto-increment.
- H. Click on the "Add new property" button and add and describe the data field names you want to use in your new project.
- I. Click on the "Next step" button to go to step 2 and configure the biometric settings.

## 2. Biometric settings

During step 2 you can add the biometric images you need in your project and determine how they will be stored.

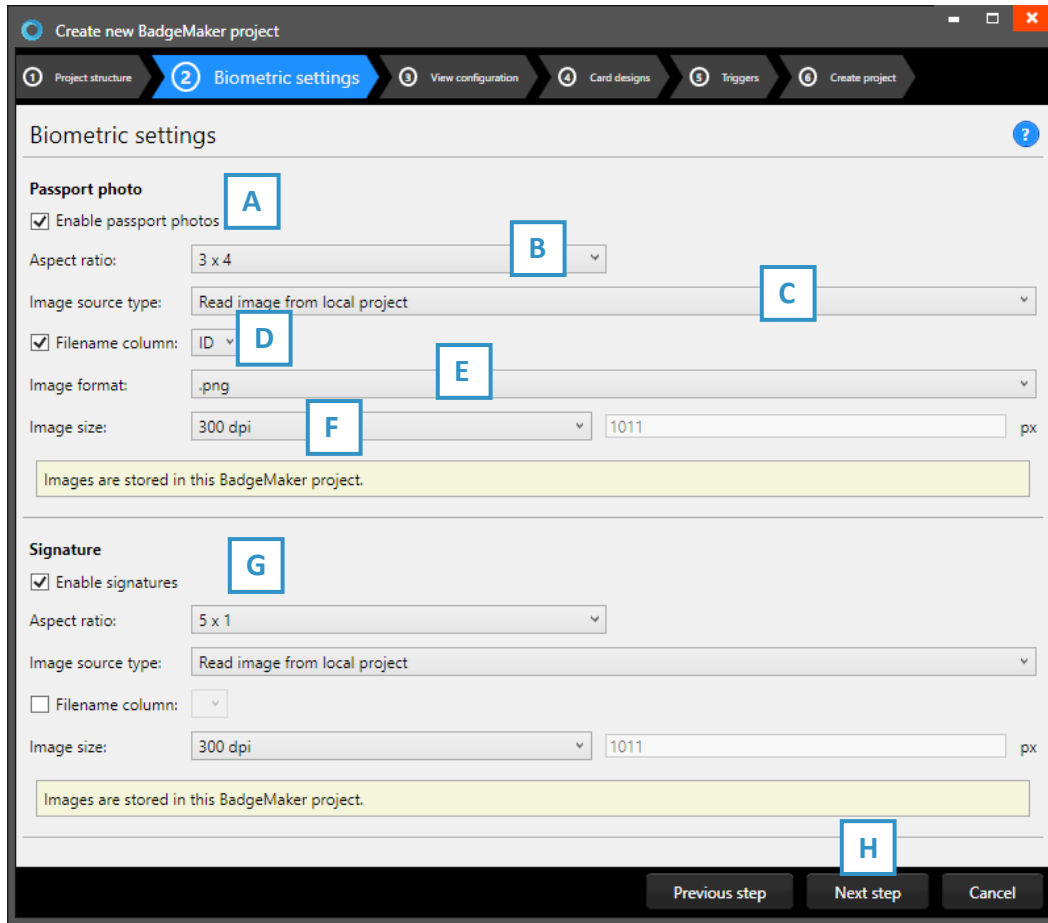

Fig. Example of step 2. New project: Biometric settings

- A. The box for passport photos makes photos visible in the project and enables you to add photos.
- B. After checking the box, you can determine the ratio of the photo.
- C. Select how and where photos will be saved within your project.
- D. Check this box if you want to use data columns to represent the filename.
- E. Select the image format (.png, .jpg or .bmp) the photos need to be saved as within your project.
- F. Here you can select what size the photos need to be saved as within your project.
- G. The process for signatures works the same as the photo settings.
- H. Click on the “Next step” button to go to step 3 and configure the view configuration.

### 3. View configuration

During step 3 you can choose the default configuration or adjust the setup for Detailed and Gallery view.

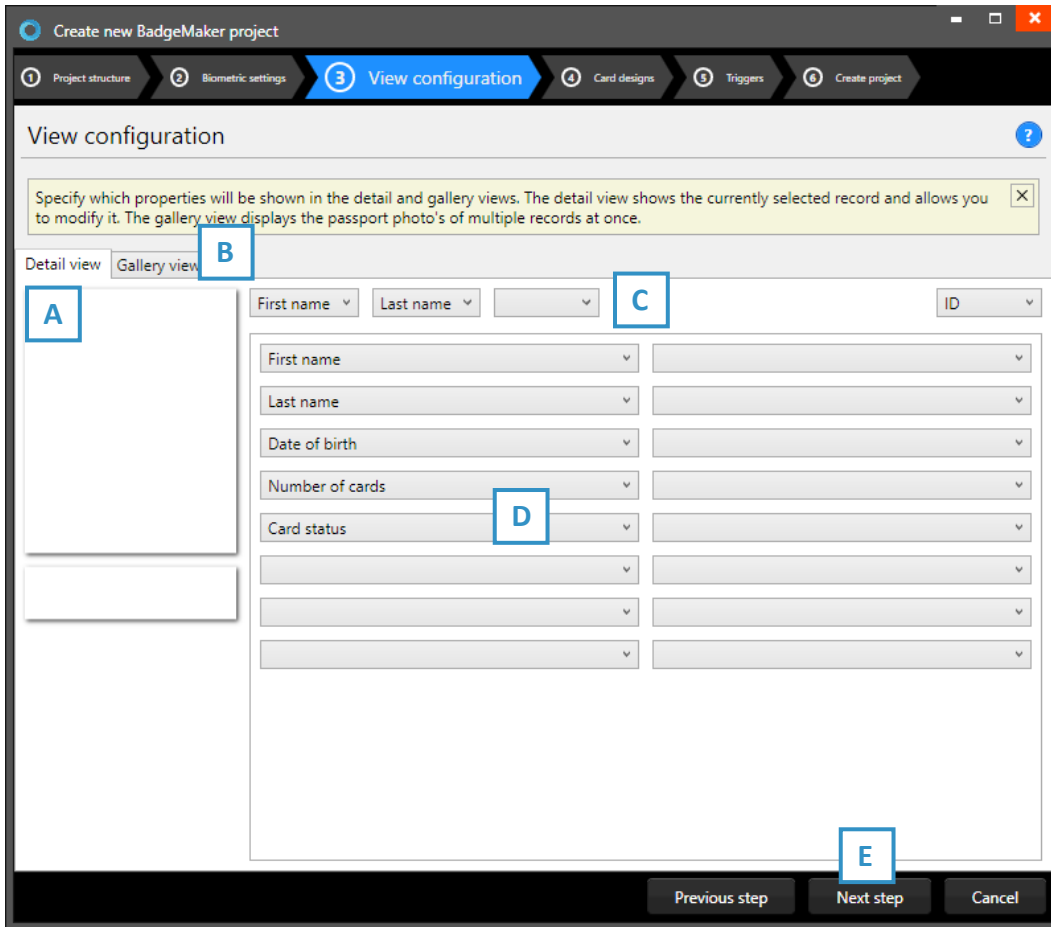
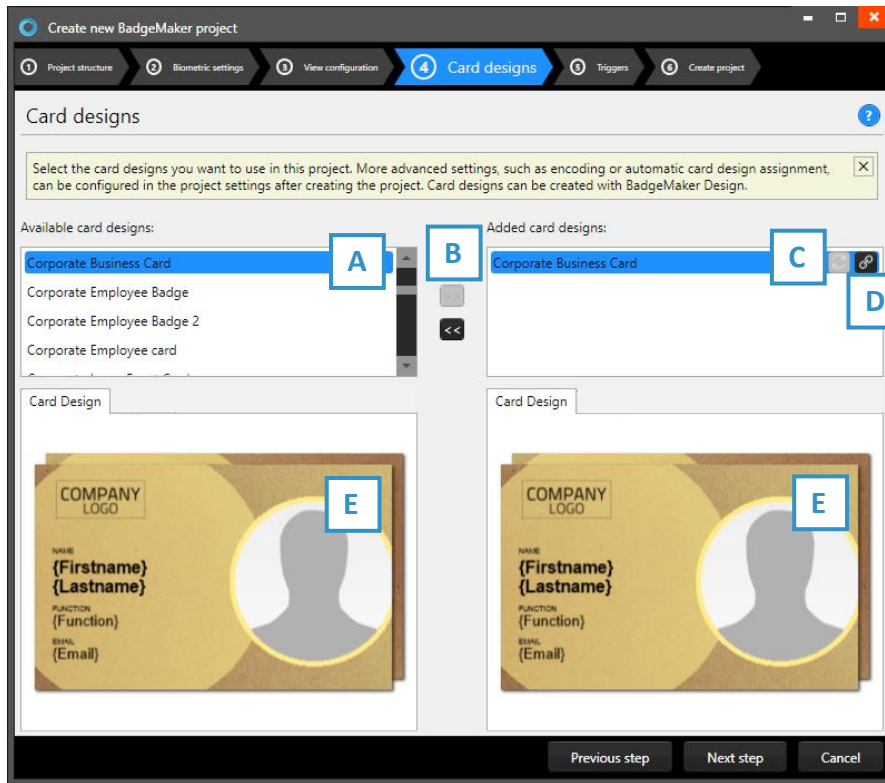

Fig. Example of step 3. New project: view configuration

- A. Tab to configure Detailed view showing specific cardholders' information.
- B. Tab to configure Gallery view showing cardholders photos.
- C. Setup the title for the detailed view.
- D. Setup the information that will be shown in the detailed view.
- E. Click on the "Next step" button to go to step 3 and add triggers to the project.

## 4. Card designs

Step 4. allows you to add card designs to your new project.



- A. Select one of the available designs.
- B. Click on the “>>” button to add a selected design to your project. Click on the “<<” button to remove a selected card design from your project.
- C. A card design in your project has two icons available, this is the “Update” icon:



An adjusted card design can be updated to the latest version by clicking on the update icon.

Fig. Example of step 4. Add Card designs to your project.

- D. A card design in your project has two icons available, this is the “Bindings” icon:

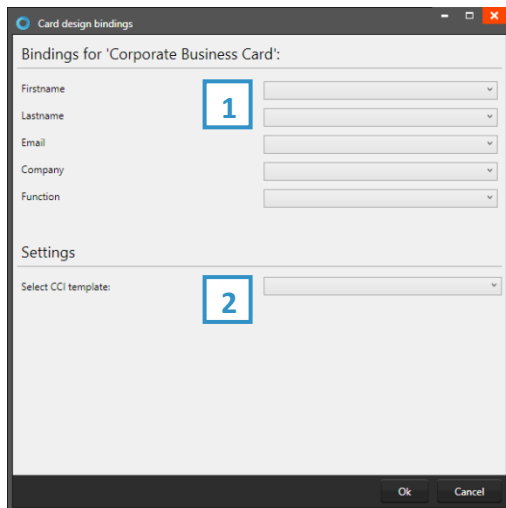

Click on the bindings icon to edit the bindings for the dynamic data of the card design. The bindings window pops up automatically after adding a design to your project. The data binding tool is a powerful option in BadgeMaker Identity. When you add a new layout or update a layout you will be prompted to create the data bindings. Dynamic fields used and created in your layout may differ from the naming or spelling of a name that exists in your Project database. Therefore, you will be allowed to create the data bindings.

### 1. Card Design bindings

The dynamic fields that are created in the card design are presented to the left and you can bind these dynamic fields to the database fields of your project.

### 2. Settings

**CCI template:** Bind a CCI encode template to your card design to encode the card during production. For more information go to “[BadgeMaker Encode](#)”. If you do not need to encode with this card design, you can leave this option blank.

- E. The Card Designs tab offers a preview of the card design. If the card design has a front and a back, you can toggle between the two by clicking on the design in the preview.

## 5. Triggers

Step 5 allows you to setup trigger for your project. Triggers can be used to automatically change data in your project on a certain condition or event.

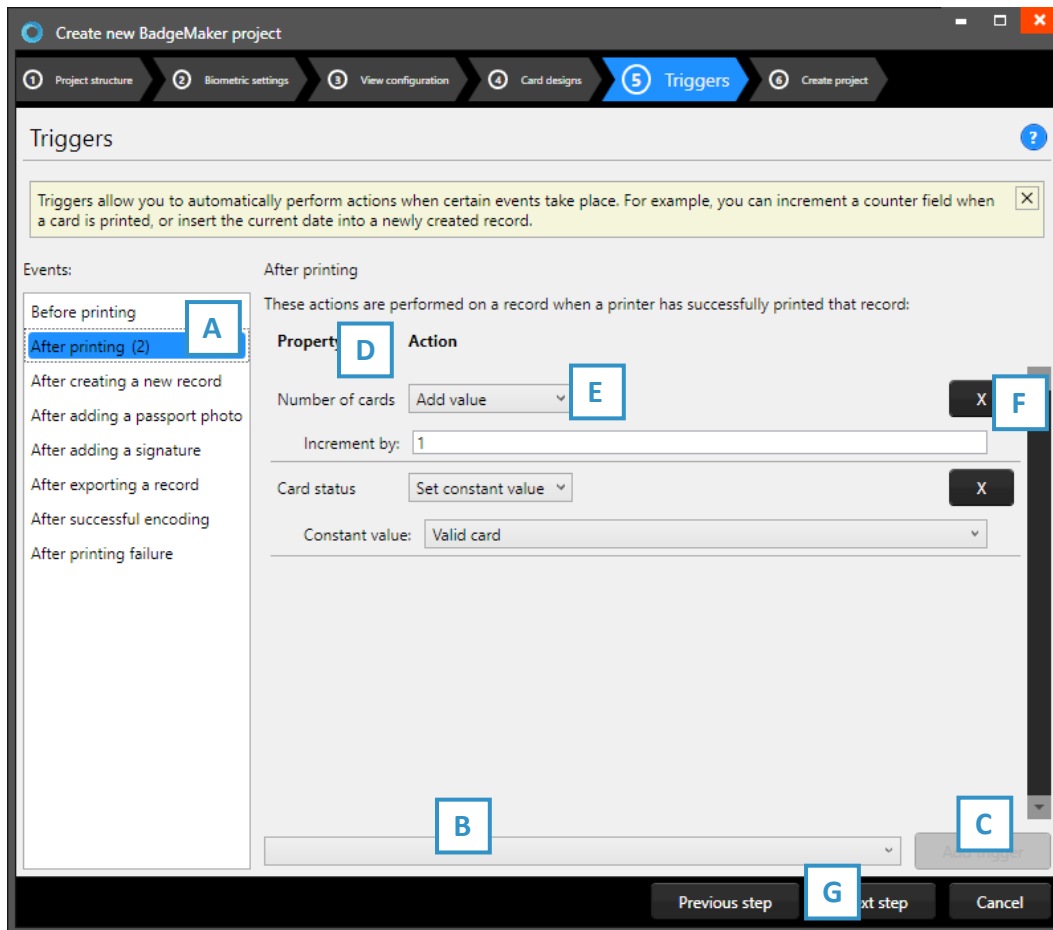

Fig. Example of step 5. New project: Triggers

- A. Select one of the events from this list and add specific triggers. BadgeMaker Identity will automatically wait for the event to occur before performing the action that is linked to the trigger.
- B. All data columns of the new project are listed. Select one of the columns to link a trigger action to it.
- C. Click on the “Add trigger” button to add the trigger to the data column and specify the trigger with events and actions.
- D. The property shows you the selected data column.
- E. Select the action you want to connect to the data column from the drop-down menu and define the action.
- F. Click on the “X” button to delete a trigger from an event.
- G. Click on the “Next step” button to go to step 4 and create the project.

Define the action that is performed once the event has been met. Some actions are only available for specific columns (for example, incrementing number values can only be done on Number type columns). All changes need to be saved before they become active. Understand that triggers might cause your original data to change, so make sure no vital data is lost when working with triggers.

## 6. Create project

During step 6 the application will start creating your new project after you click on the A. “Create project” button. If there are problems read the feedback provided and click on the B. “Previous” button to go back and make the needed adjustments.

You are now ready to start adding records to your data grid.

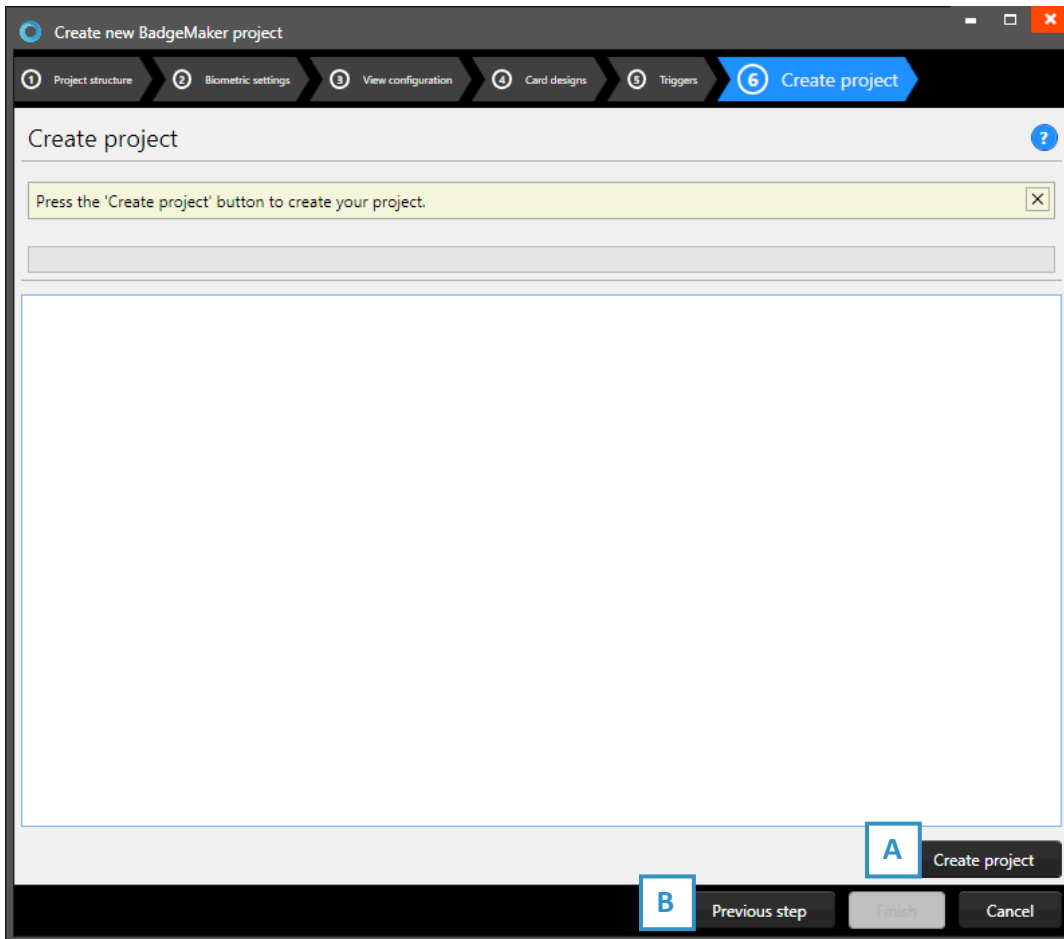

Fig. Example of step 6. New project: Create project.



## B. Create a new BadgeMaker Connect project

To create a new BadgeMaker Connect project you need the Connect Add-On. An Add-On can be added to your BadgeMaker Base package or you can choose the BadgeMaker PRO package that already contains the Connect Add-On. The BadgeMaker Connect Add-On lets you connect with external databases. Go to the BadgeMaker Connect chapter for more information about the functionalities of this Add-On.

### 1. Data sources

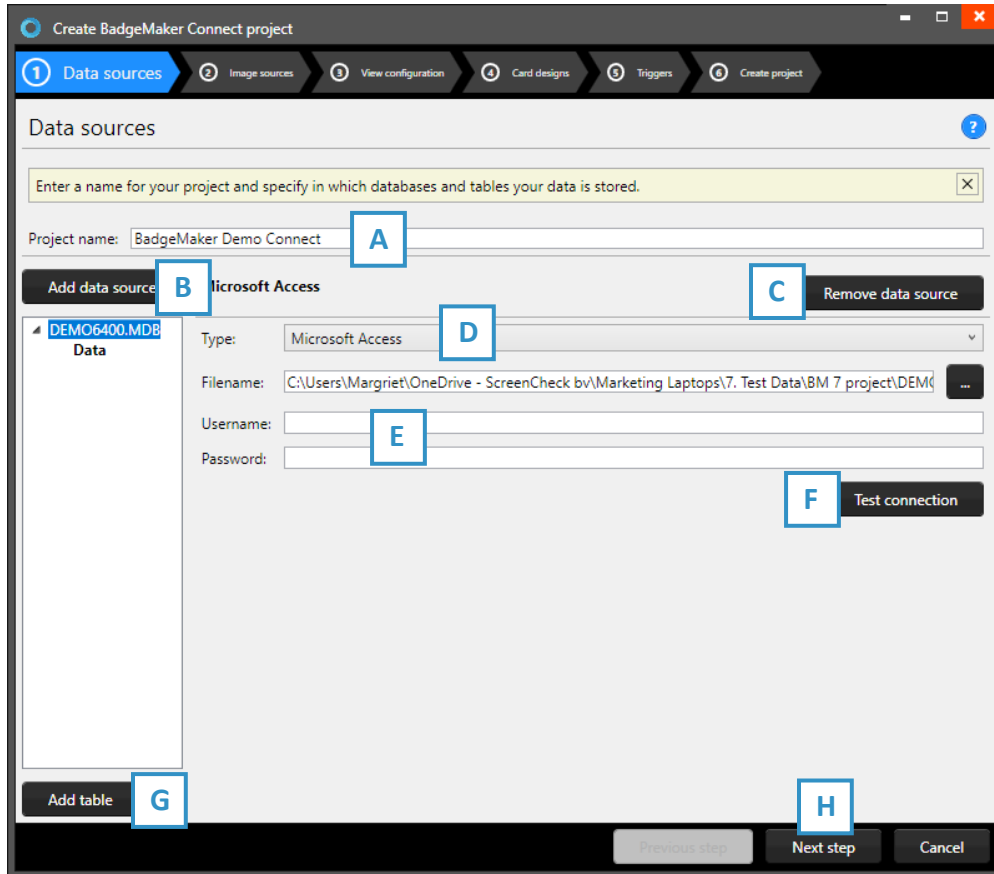

Fig. Example of a New BadgeMaker Connect project with Microsoft SQL database connection step 1: data sources

- A. Give your BadgeMaker Connect project a unique name.
- B. Click on “Add data source” to add a database connection to your new project.
- C. Select an added database connection and click on “Remove data source” to remove a connection.
- D. Select the type of Database you want to connect with, give the Server name, Port number and database name. Several database types are supported:
  - Microsoft SQL Server
  - Microsoft Access files
  - MySQL Server
  - Oracle Server
  - ODBC
- E. When an external database is secured with credentials, you can add those credentials here.
- F. Click on “Test connection” to test the connection with the external database.
- G. Select the added database connection and click on “Add table” to add a table from your database to the project.
- H. Click on “Next” to continue to the next step.

## 2. Image sources

Step 2. Specify where your biometric images are located.

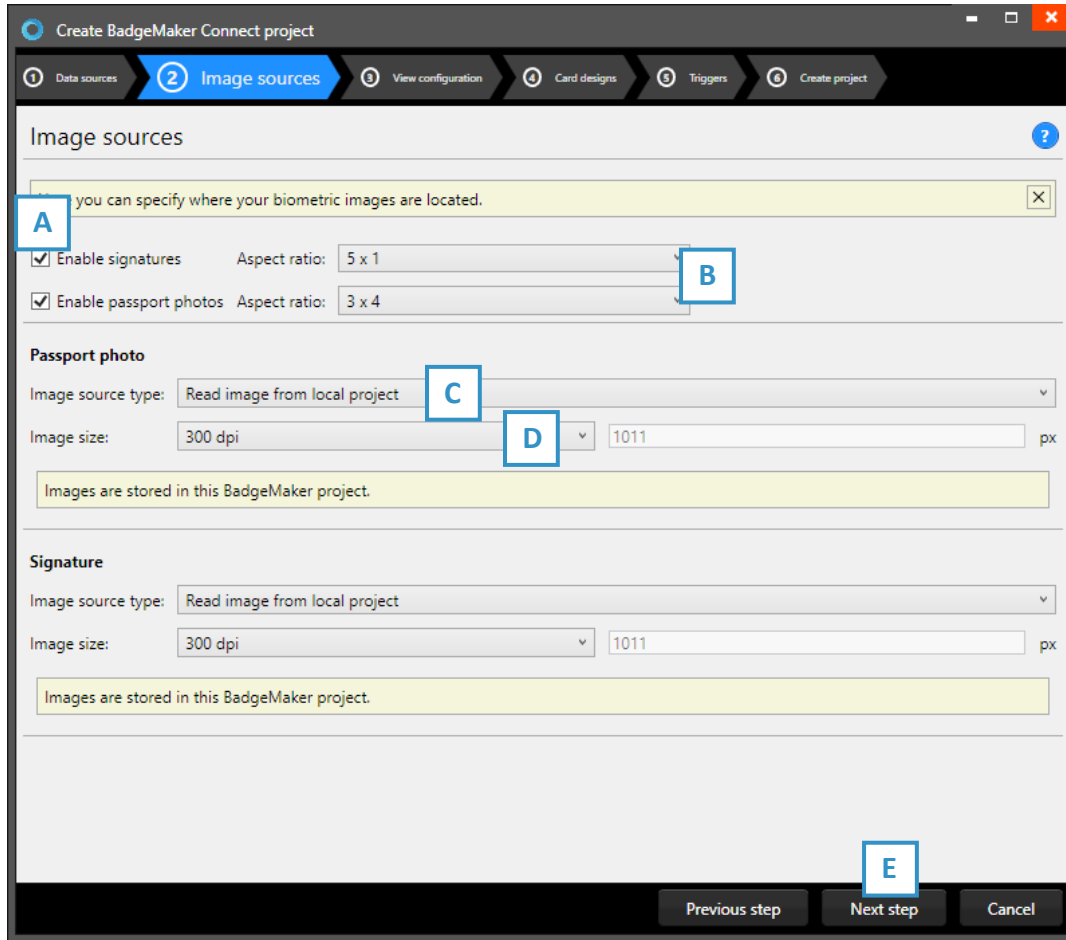

Fig. Example of a new Connect project with database connection step 2. Image sources.

- A. Check the box when you want to add signatures and/or passport photos to your project.
- B. After checking the box, you can determine the ratio of the photo.
- C. Select where the image source type, so from where the images need to be imported into your project.
- D. Here you can select what size the photos need to be saved as within your project.
- E. Click on the “Next step” button to go to step 3 and configure the detailed and gallery view

### 3. View configuration

During step 3 you can select the default configuration or adjust the setup for Detailed and Gallery view.

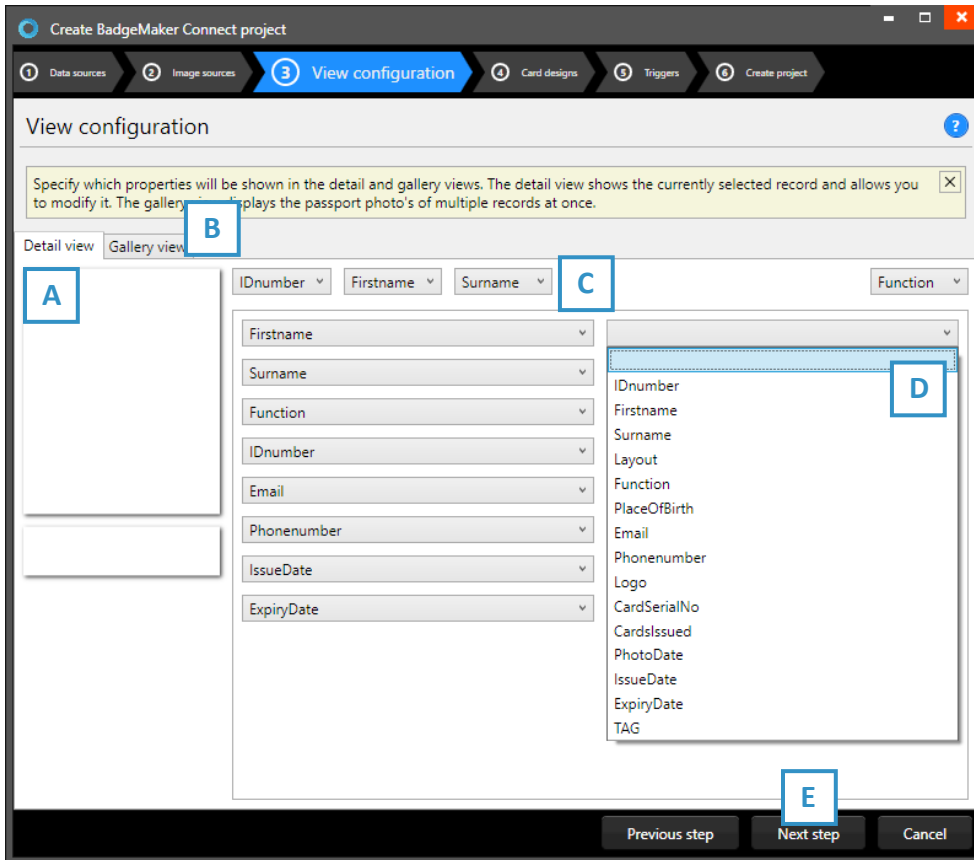
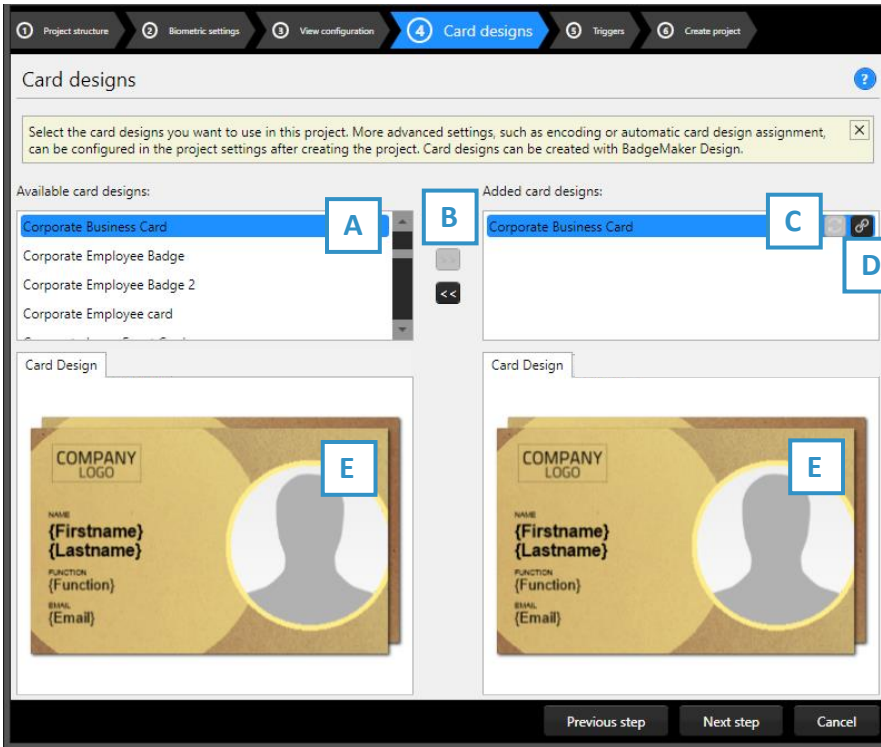

Fig. Example of step 3. New Connect project: View configuration

- A. Tab to configure Detailed view showing specific cardholders' information.
- B. Tab to configure Gallery view showing cardholders photos.
- C. Setup the title for the detailed view.
- D. Setup the information that will be shown in the detailed view.
- E. Click on the "Next step" button to go to step 3 and add triggers to the project.

#### 4. Card designs

Step 4. allows you to add card designs to your new project.



- A. Select one of the available designs.
- B. Click on the “>>” button to add a selected design to your project. Click on the “<<” button to remove a selected card design from your project.
- C. A card design in your project has two icons available, this is the “Update” icon:



An adjusted card design can be updated to the latest version by clicking on the update icon.

Fig. Example of step 4. Add Card designs to your project.

- D. A card design in your project has two icons available, this is the “Bindings” icon:

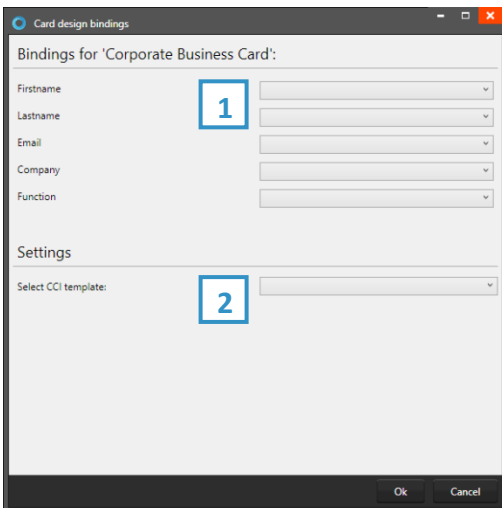

Click on the bindings icon to edit the bindings for the dynamic data of the card design. The bindings window pops up automatically after adding a design to your project. The data binding tool is a powerful option in BadgeMaker Identity. When you add a new layout or update a layout you will be prompted to create the data bindings. Dynamic fields used and created in your layout may differ from the naming or spelling of a name that exists in your Project database. Therefore, you will be allowed to create the data bindings.

##### 1. Card Design bindings

The dynamic fields that are created in the card design are presented to the left and you can bind these dynamic fields to the database fields of your project.

##### 2. Settings

**CCI template:** Bind a CCI encode template to your card design to encode the card during production. For more information go to “[BadgeMaker Encode](#)”. If you do not need to encode with this card design, you can leave this option blank.

- E. The Card Designs tab offers a preview of the card design. If the card design has a front and a back, you can toggle between the two by clicking on the design in the preview.

## 5. Triggers

Step 5 allows you to setup trigger for your project. Triggers can be used to automatically change data in your project on a certain condition or event.

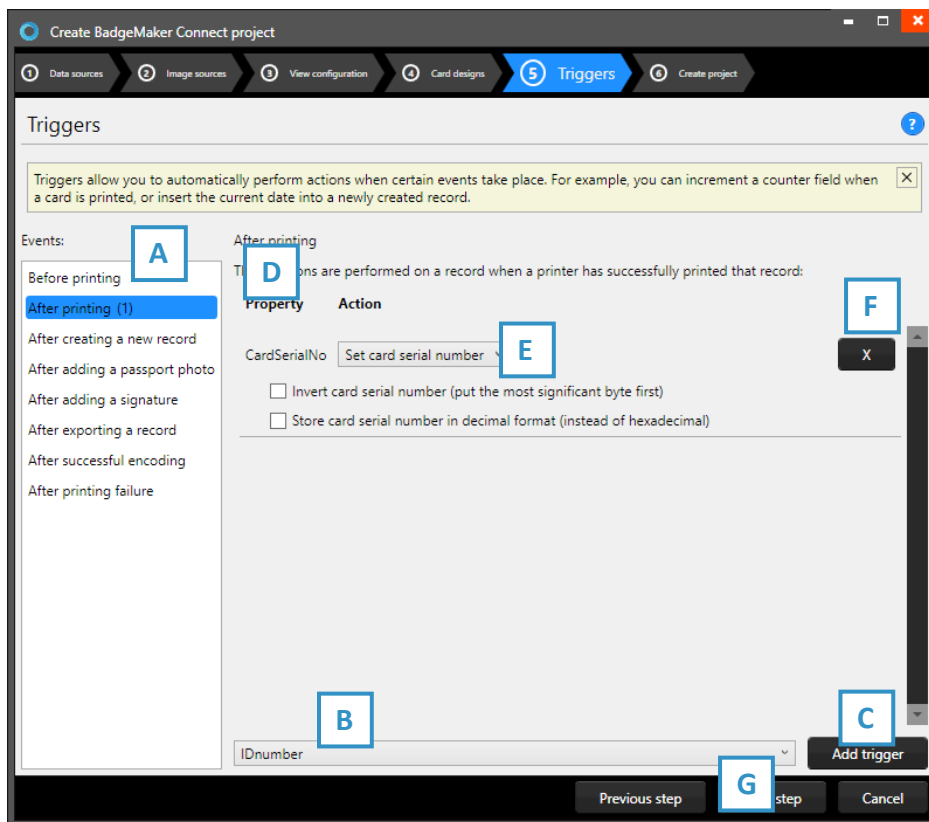

Fig. Example of step 5. New Connect project: Triggers

- A. Select one of the events from this list and add specific triggers. BadgeMaker Identity will automatically wait for the event to occur before performing the action that is linked to the trigger.
- B. All data columns of the new project are listed. Select one of the columns to link a trigger action to it.
- C. Click on the “Add trigger” button to add the trigger to the data column and specify the trigger with events and actions.
- D. The property shows you the selected data column.
- E. Select the action you want to connect to the data column from the drop-down menu and define the action.
- F. Click on the “X” button to delete a trigger from an event.
- G. Click on the “Next step” button to go to step 4 and create the project.

Define the action that is performed once the event has been met. Some actions are only available for specific columns (for example, incrementing number values can only be done on Number type columns). All changes need to be saved before they become active. Understand that triggers might cause your original data to change, so make sure no vital data is lost when working with triggers.

### 6. Create project

During step 6 the application will start creating your new connect project after you click on the A. “Create project” button. If there are problems, read the feedback provided and click on the B. “Previous” button to go back and make the needed adjustments.

You are now ready to start adding records to your data grid.

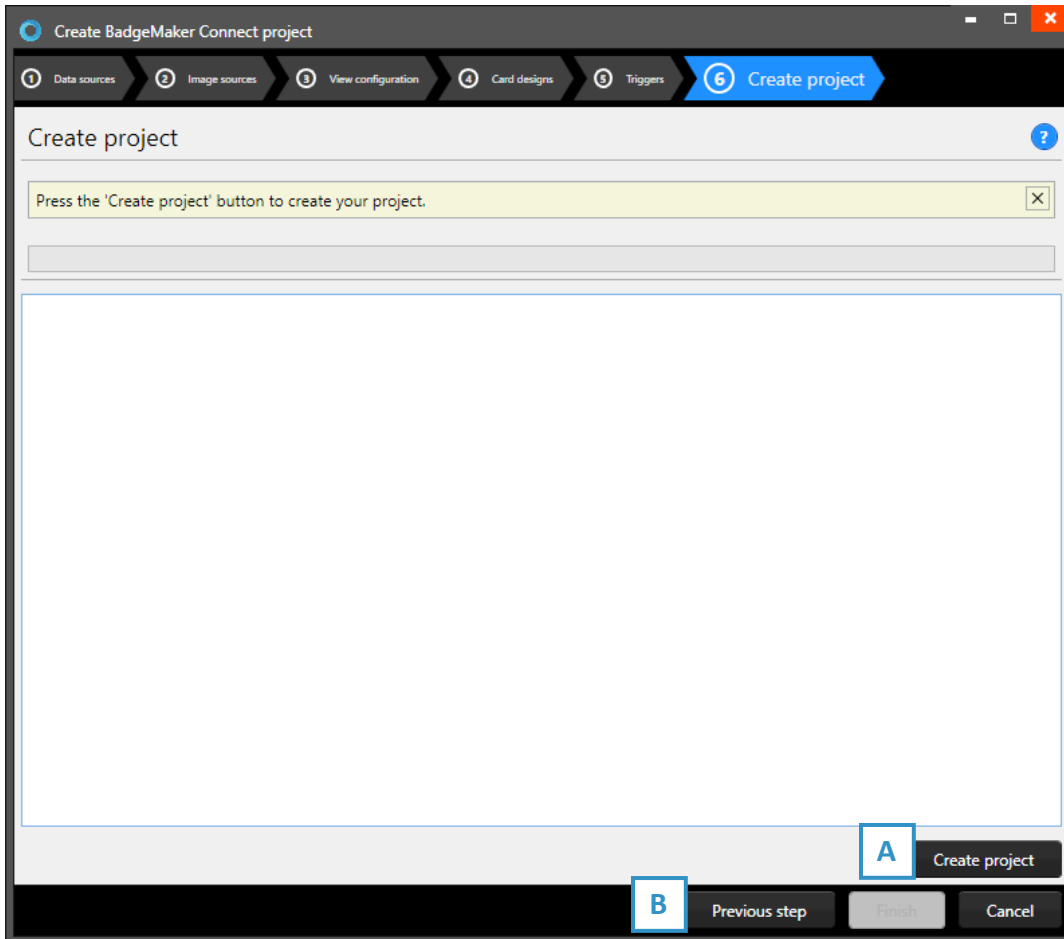

Fig. Example of step 6. Connect project: Create project.

## C. Create copy of an existing Project

### 1. Select Project

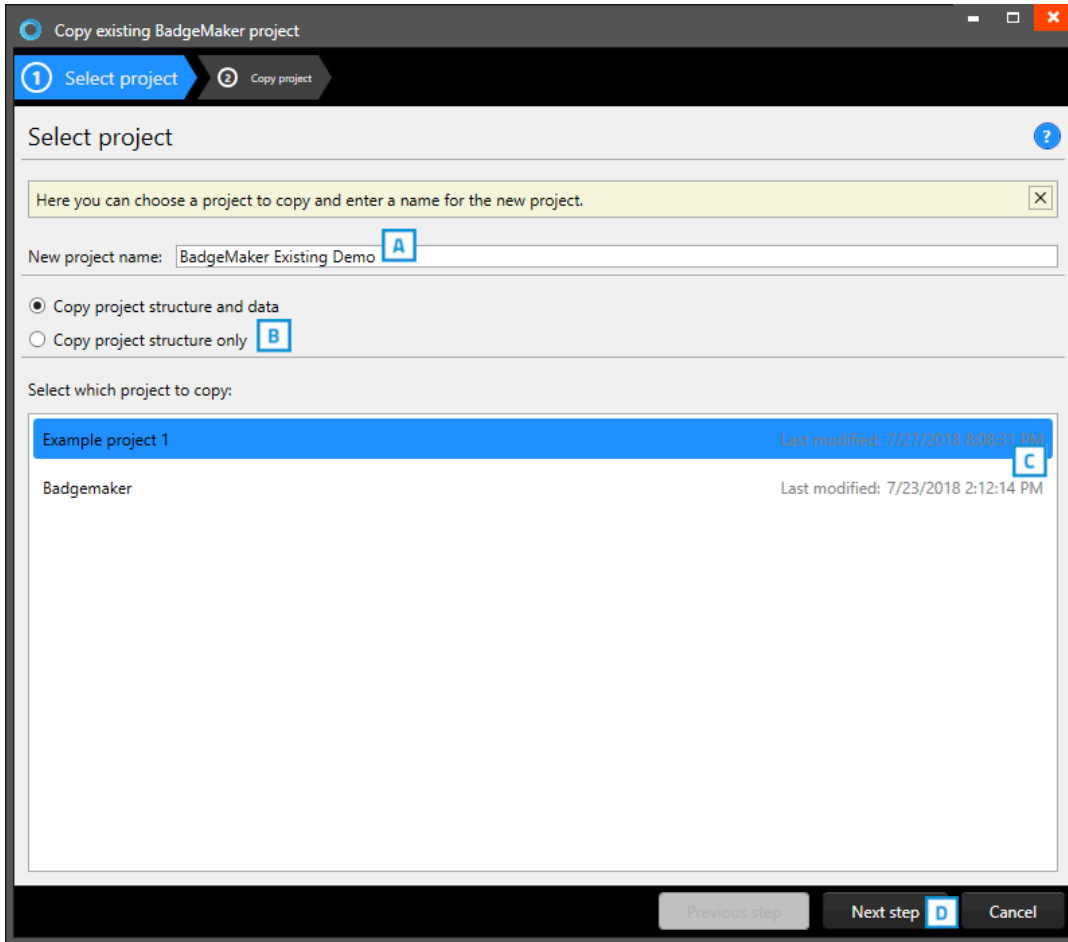

Fig. Example of step 1. New project: Copy existing project.

- A. Rename the project.
- B. Select if you want the copy with data or structure only. Select structure only if you only want the data field setup and not the content of the previous project.
- C. Select an existing project from the list presented.
- D. Click on the "Next step" button to create the copied project.

## 2. Copy project

During step 2 the application will start creating a copy of the project after you click on the A. “Create project” button. Select B. to make changes in the previous step. You are now ready to start adding records to your data grid.

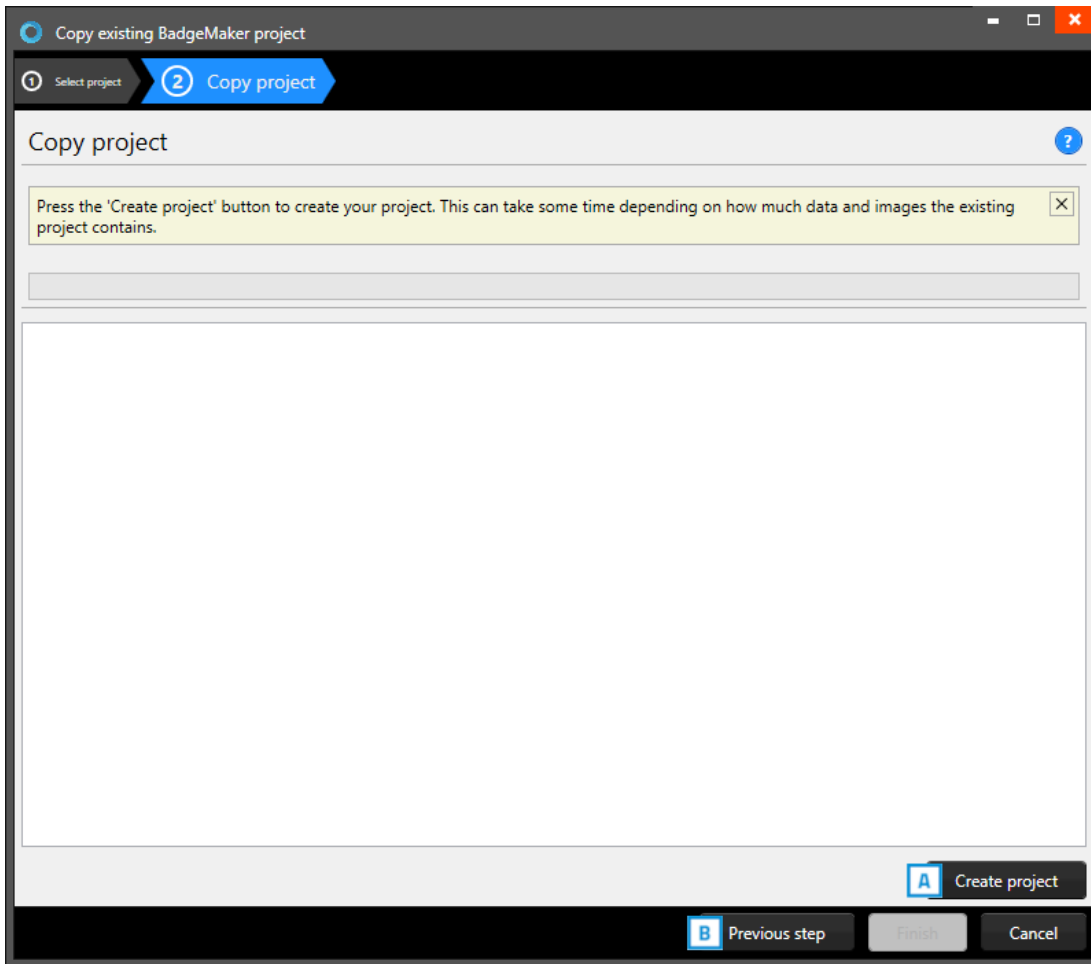

Fig. Example of step 2. New project: Copy project.



## D. Import Project from Excel

### 1. Data source

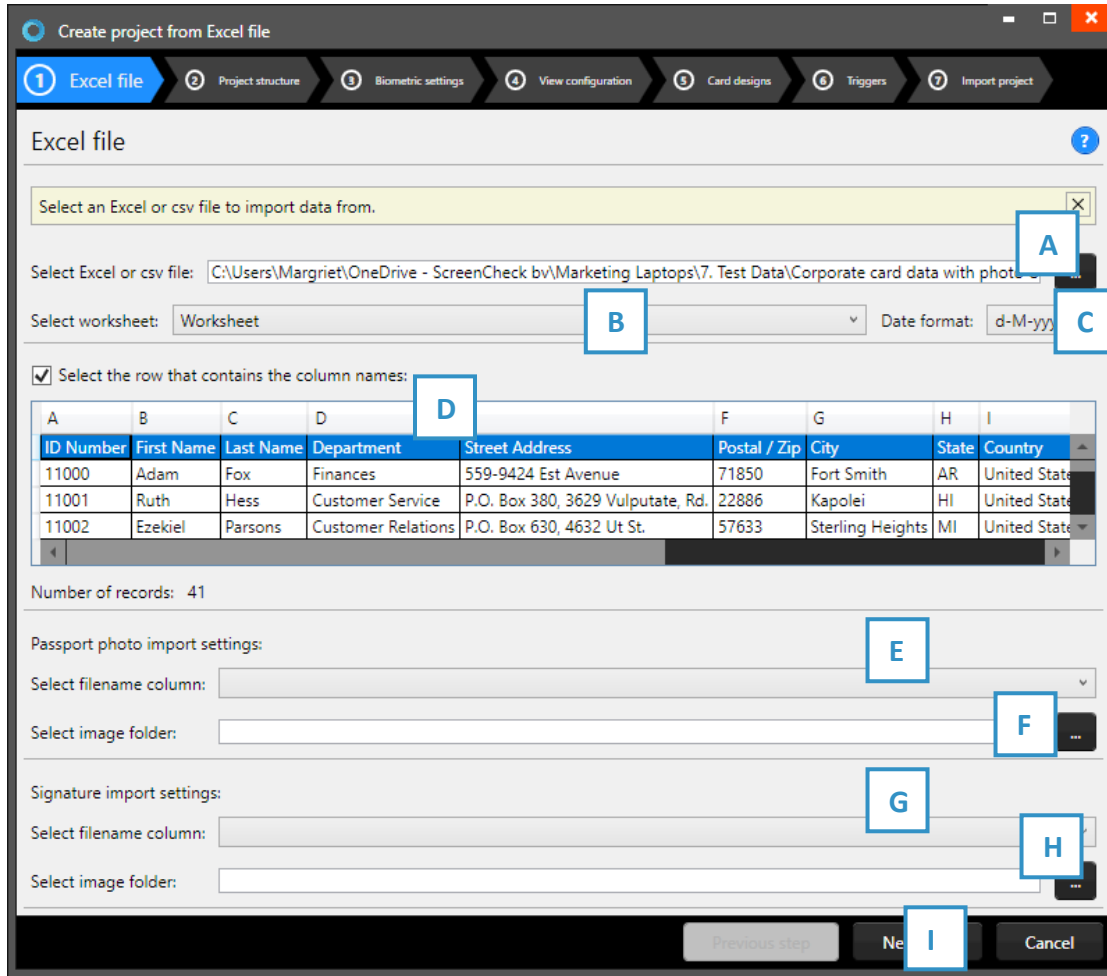

Fig. Example of step 1. New project imported from excel file: Data source.

- A. Click on this button and select the Excel/CSV file you want to import and create a new project with.
- B. Select the worksheet you want to use from the drop-down menu.
- C. Select the date format you are using with your Excel file.
- D. Select the row that contains the column names.
- E. Select the column that connects with the unique photo names (for example: ID number or index).
- F. Select the folder that contains the cardholders' photos.
- G. Select the column that connects with the unique signature names (for example: ID number or index).
- H. Select the folder that contains the signatures.
- I. Click on the "Next step" button to continue to second step.

## 2. Project structure

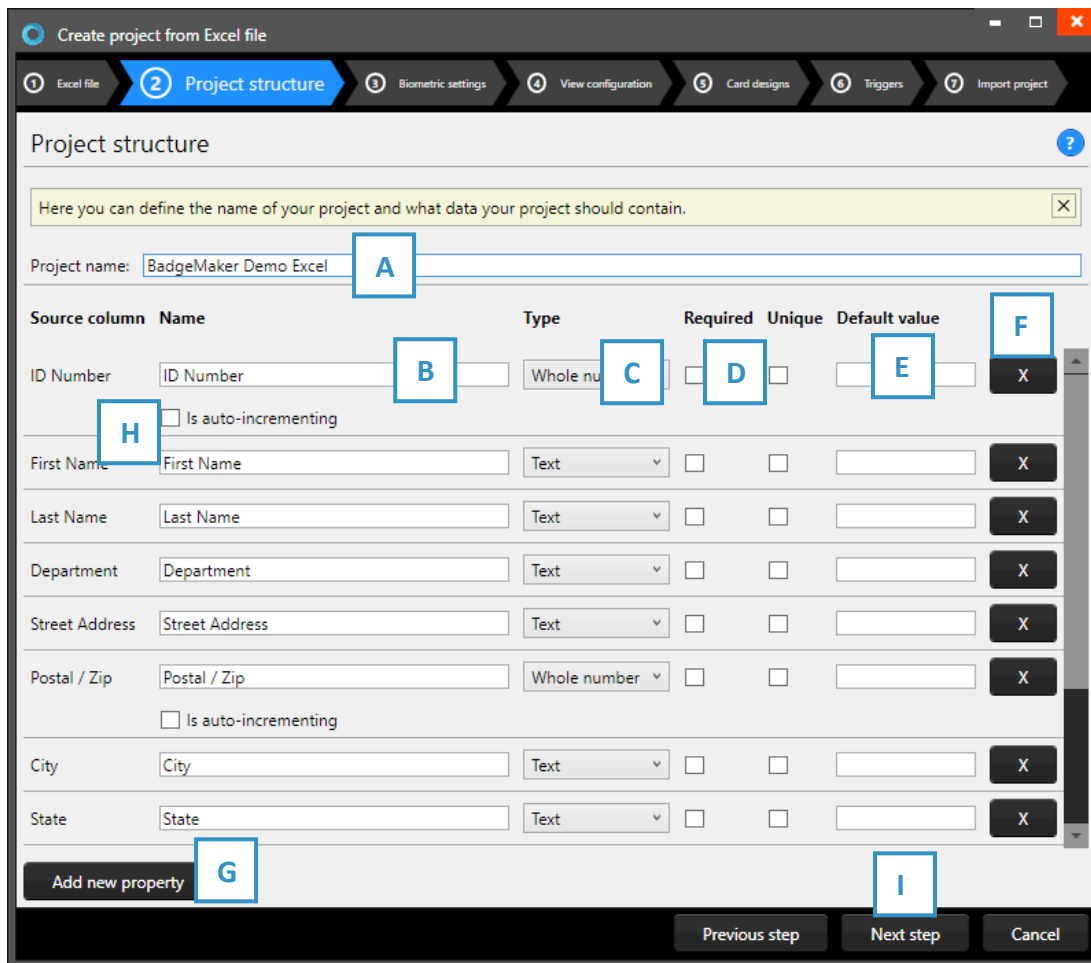

Fig. Example of step 2. New project: Project data columns

- A. Enter the name of your new project.
- B. Enter the column name.
- C. Set the data type. Select if the data are number or text for example. The following types of database fields are supported:
  - Whole Number, when selecting this type, you can select 'auto-increment'. When a new record is created the number will be the highest number in the Project increased by 1.
  - Text
  - Decimal number
  - Option List, when this list type is selected you can add and delete the list values from the list that is presented for this database field.
- D. Check these boxes if the field needs to be "Required" and/or "Unique".
- E. With the default input field, you can add a standard value to your data field, existing empty fields and new records will automatically display the default value you add to this data field.
- F. Click on the "X" button to delete a data field from the project structure setup.
- G. Click on the "Add new property" button and add and describe the data field names you want to use in your new project.
- H. Click on the "Next step" button to go to step 3 and configure the biometric settings.

### 3. Biometric settings

During step 3 you can add the biometric images you need in your project and determine how they will be stored.

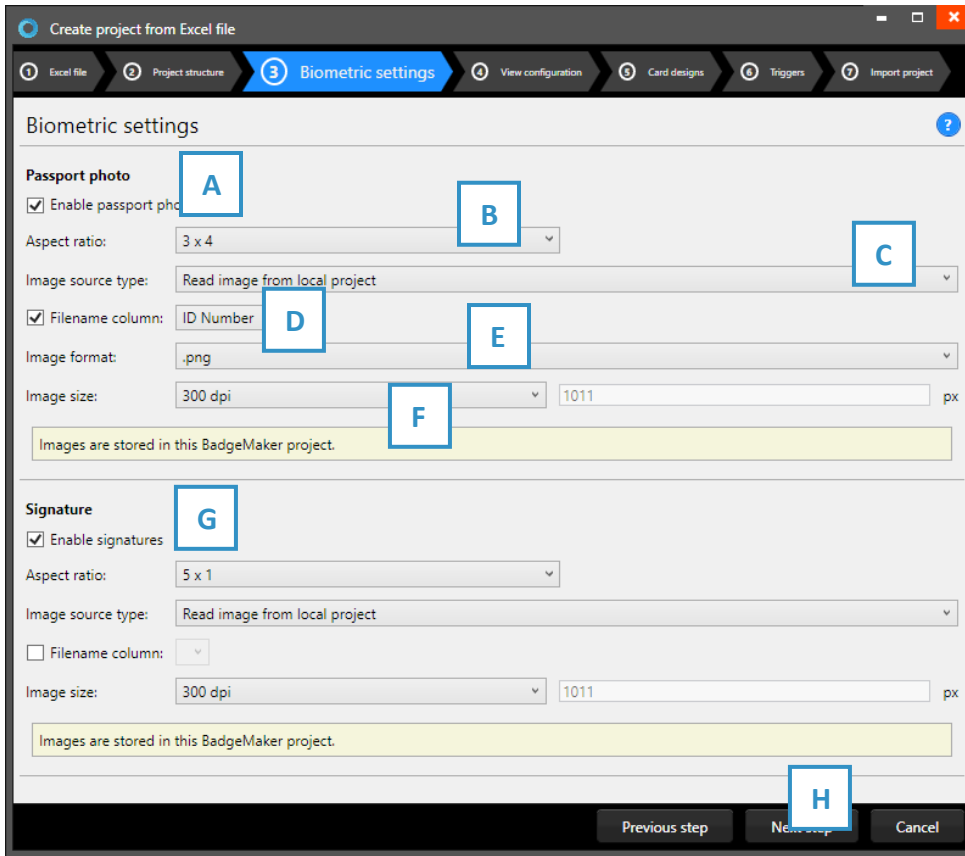

Fig. Example of step 3. New project: Biometric settings

- A. The box for passport photos makes photos visible in the project and enables you to add photos.
- B. After checking the box, you can determine the ratio of the photo.
- C. Select how and where photos will be saved within your project.
- D. Check this box if you want to use data columns to represent the filename.
- E. Select the image format (.png, .jpg or .bmp) the photos need to be saved as within your project.
- F. Here you can select what size the photos need to be saved as within your project.
- G. The process for signatures works the same as the photo settings.
- H. Click on the “Next step” button to go to step 4. and configure the view configuration.

#### 4. View configuration

During step 4 you can select the default configuration or adjust the setup for Detailed and Gallery view.

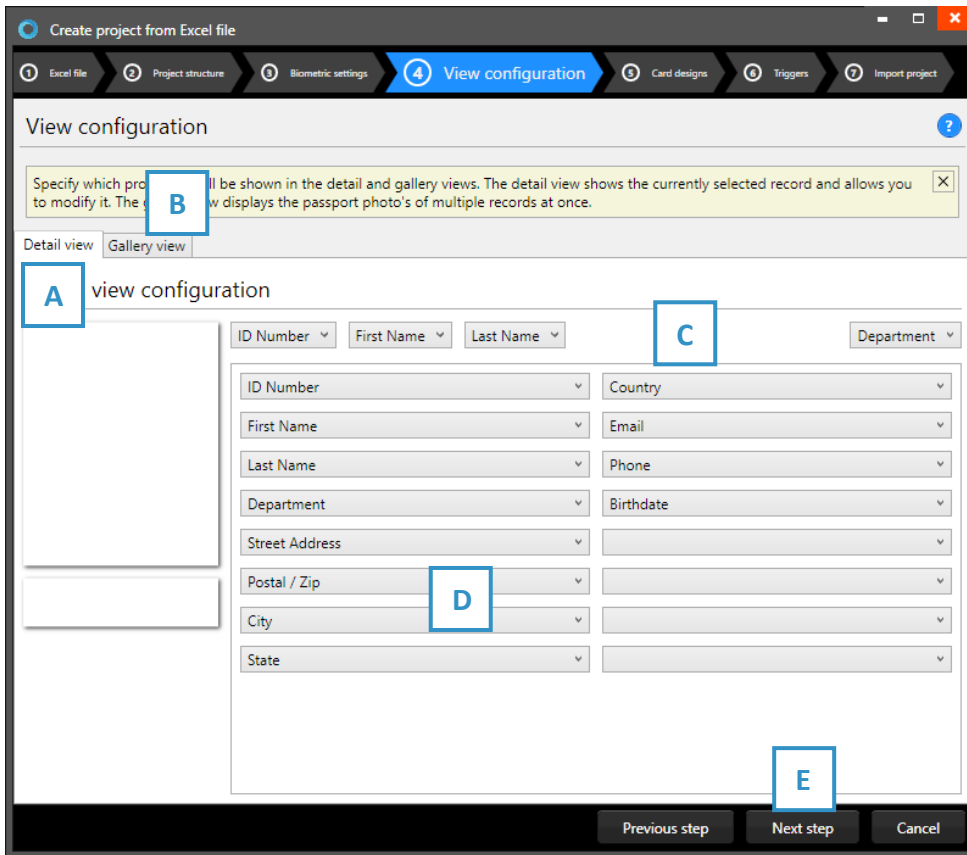
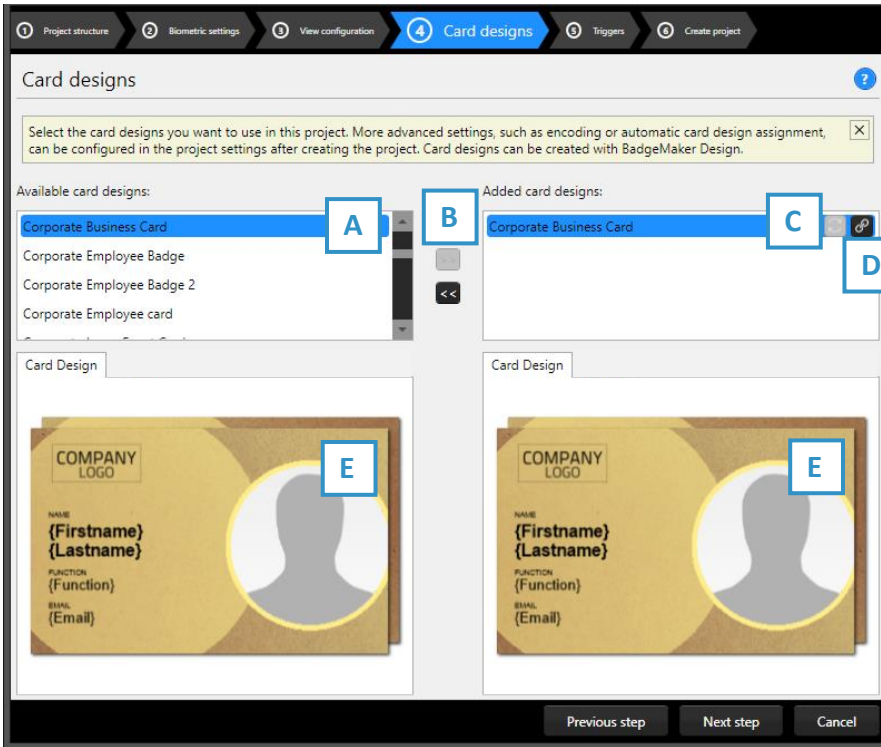

Fig. Example of step 4. New project: View configuration

- A. Tab to configure Detailed view showing specific cardholders' information.
- B. Tab to configure Gallery view showing cardholders photos.
- C. Setup the title for the detailed view.
- D. Setup the information that will be shown in the detailed view.
- E. Click on the "Next step" button to go to step 5. And add triggers to the project.

## 5. Card designs

Step 5. allows you to add card designs to your new project.



- A. Select one of the available designs.
- B. Click on the “>>” button to add a selected design to your project. Click on the “<<” button to remove a selected card design from your project.
- C. A card design in your project has two icons available, this is the “Update” icon:



An adjusted card design can be updated to the latest version by clicking on the update icon.

Fig. Example of step 4. Add Card designs to your project.

- D. A card design in your project has two icons available, this is the “Bindings” icon:

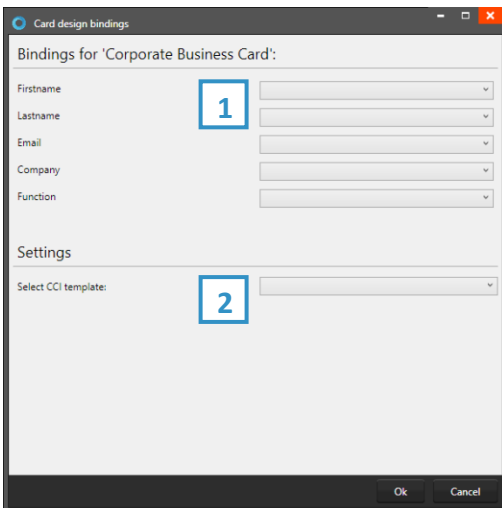

Click on the bindings icon to edit the bindings for the dynamic data of the card design. The bindings window pops up automatically after adding a design to your project. The data binding tool is a powerful option in Badgemaker Identity. When you add a new layout or update a layout you will be prompted to create the data bindings. Dynamic fields used and created in your layout may differ from the naming or spelling of a name that exists in your Project database. Therefore, you will be allowed to create the data bindings.

### 1. Card Design bindings

The dynamic fields that are created in the card design are presented to the left and you can bind these dynamic fields to the database fields of your project.

### 2. Settings

**CCI template:** Bind a CCI encode template to your card design to encode the card during production. For more information go to “Badgemaker Encode”. If you do not need to encode with this card design, you can leave this option blank.

- E. The Card Designs tab offers a preview of the card design. If the card design has a front and a back, you can toggle between the two by clicking on the design in the preview.

## 6. Triggers

Step 6 allows you to setup triggers for your project. Triggers can be used to automatically change data in your project on a certain condition or event.

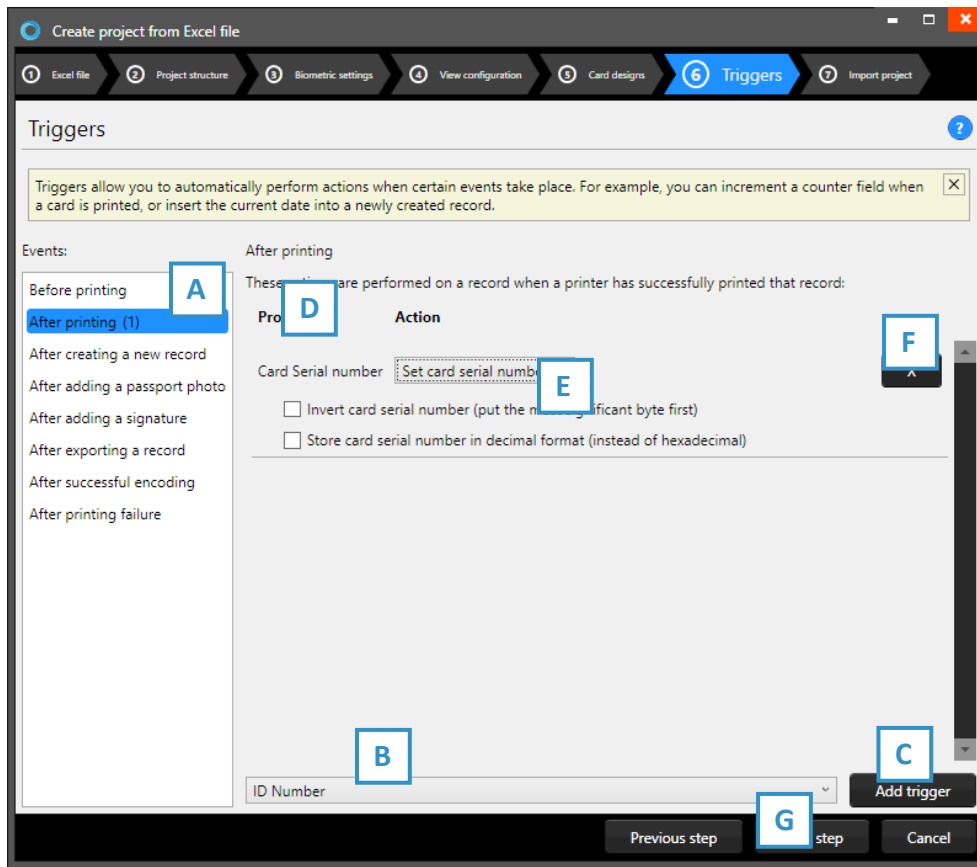

Fig. Example of step 5. New project: Triggers

- A. Select one of the events from this list and add specific triggers. BadgeMaker Identity will automatically wait for the event to occur before performing the action that is linked to the trigger.
- B. All data columns of the new project are listed. Select one of the columns to link a trigger action to it.
- C. Click on the “Add trigger” button to add the trigger to the data column and specify the trigger with events and actions.
- D. The property shows you the selected data column.
- E. Select the action you want to connect to the data column from the drop-down menu and define the action.
- F. Click on the “X” button to delete a trigger from an event.
- G. Click on the “Next step” button to go to step 7 and create the project.

Define the action that is performed once the event has been met. Some actions are only available for specific columns (for example, incrementing number values can only be done on Number type columns). All changes need to be saved before they become active. Understand that triggers might cause your original data to change, so make sure no vital data is lost when working with triggers.

## 7. Import Project

- A. Step 7 will create the new project imported from an excel file as soon as you click on the “Create project” button.
- B. Click on the “Previous step” button to make any changes before creating the project.

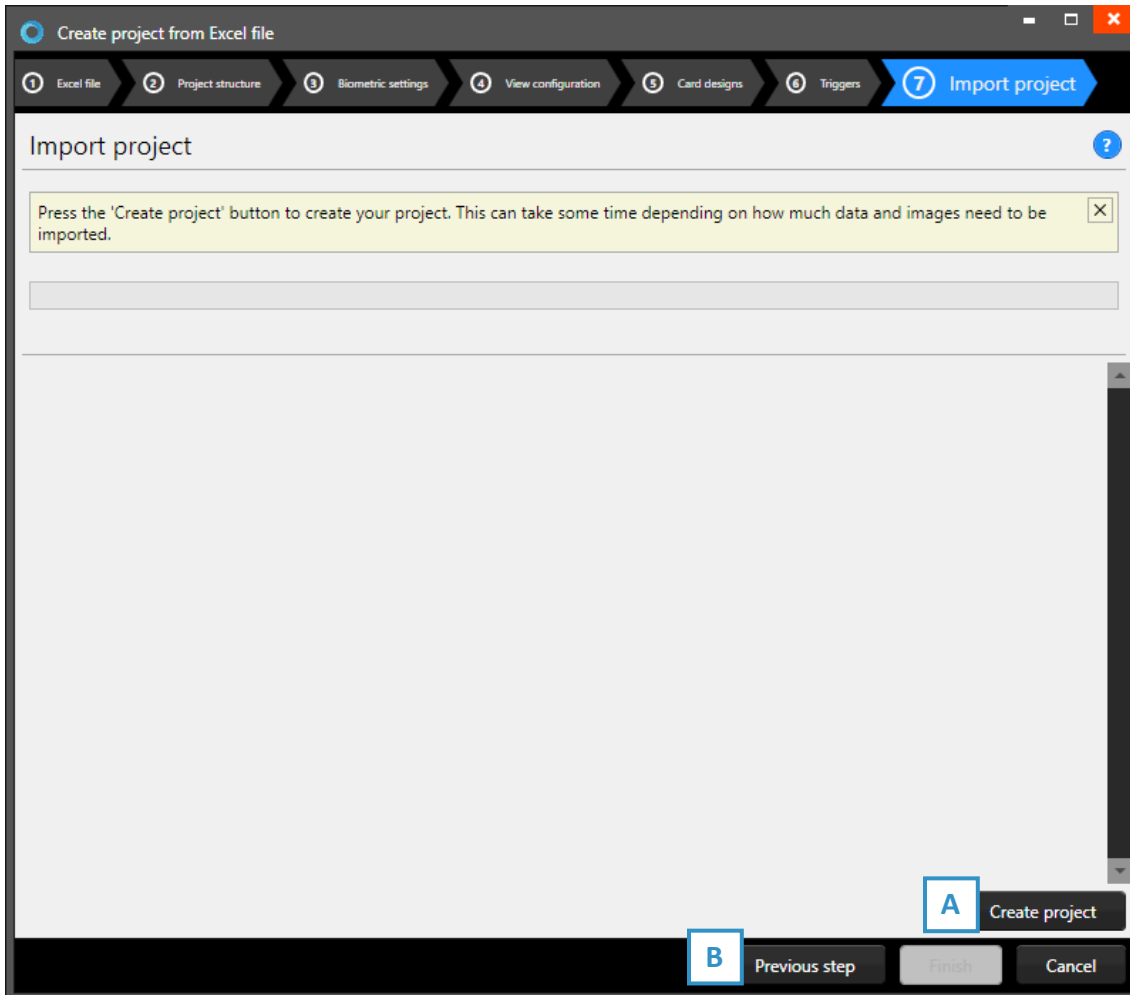

Fig. Example of step 7. New project: import new Excel project.

## E. New Project from BadgeMaker 7 Project

### 1. Select BadgeMaker 7 Project

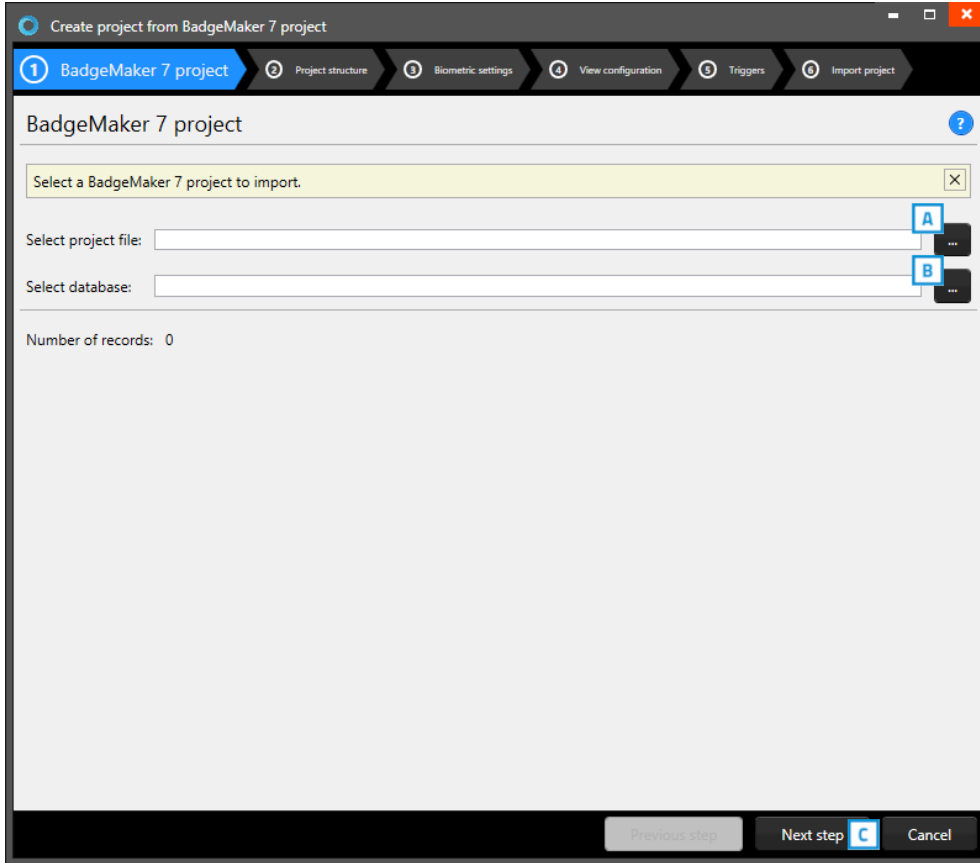

Fig. Example of step 1. New project: Select BadgeMaker 7 Project

- A. Click on this button to select the BadgeMaker 7 project from your computer.
- B. Click on this button to select the BadgeMaker 7 database from your computer.
- C. Click on the “Next step” button to go to step 2 and check the project structure.



## 2. Project structure

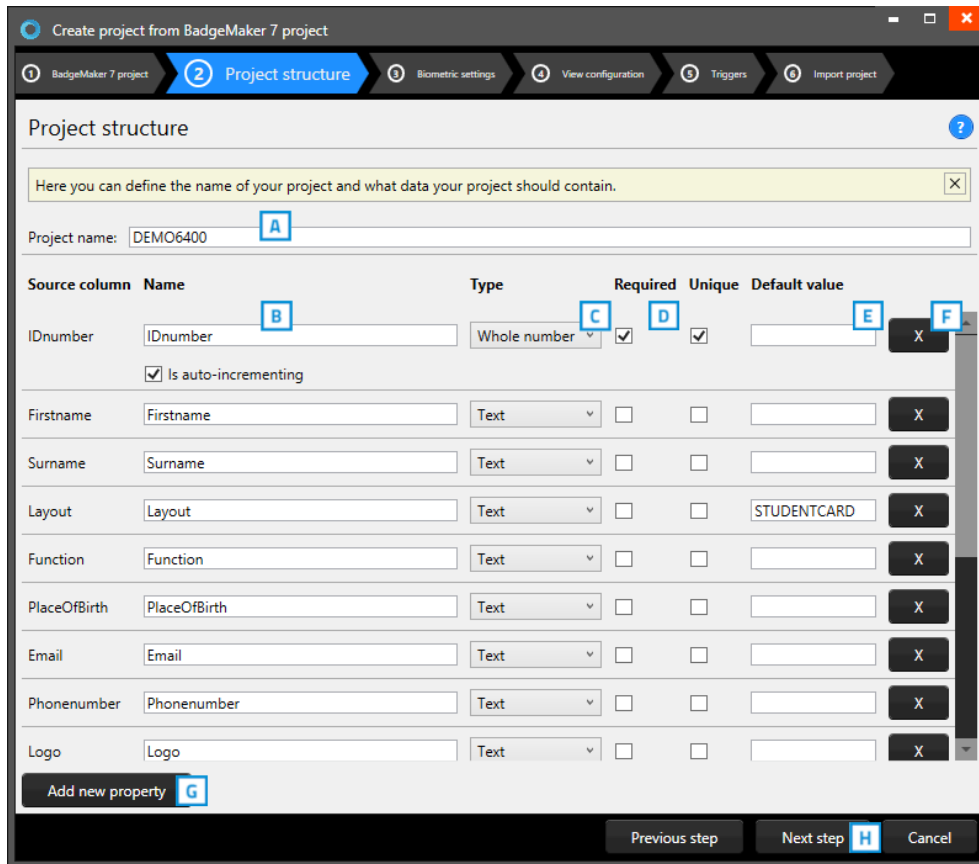

Fig. Example of step 2. New project: Project data columns.

- A. Enter the name for your new project.
- B. Enter the column name.
- C. Set the data type. Select if the data are number or text for example. The following types of database fields are supported:
  - Whole Number, when selecting this type, you can select 'auto-increment'. When a new record is created the number will be the highest number in the Project increased by 1.
  - Text
  - Decimal number
  - Option List, when this list type is selected you can add and delete the list values from the list that is presented for this database field.
- D. Check these boxes if the field needs to be "Required" and/or "Unique".
- E. With the default input field, you can add a standard value to your data field, existing empty fields and new records will automatically display the default value you add to this data field.
- F. Click on the "X" button to delete a data field from the project structure setup.
- G. Click on the "Add new property" button and add and describe the data field names you want to use in your new project.
- H. Click on the "Next step" button to go to step 3.

### 3. Biometric settings

During step 3 you can enable the biometric images you need in your project and determine how they will be stored.

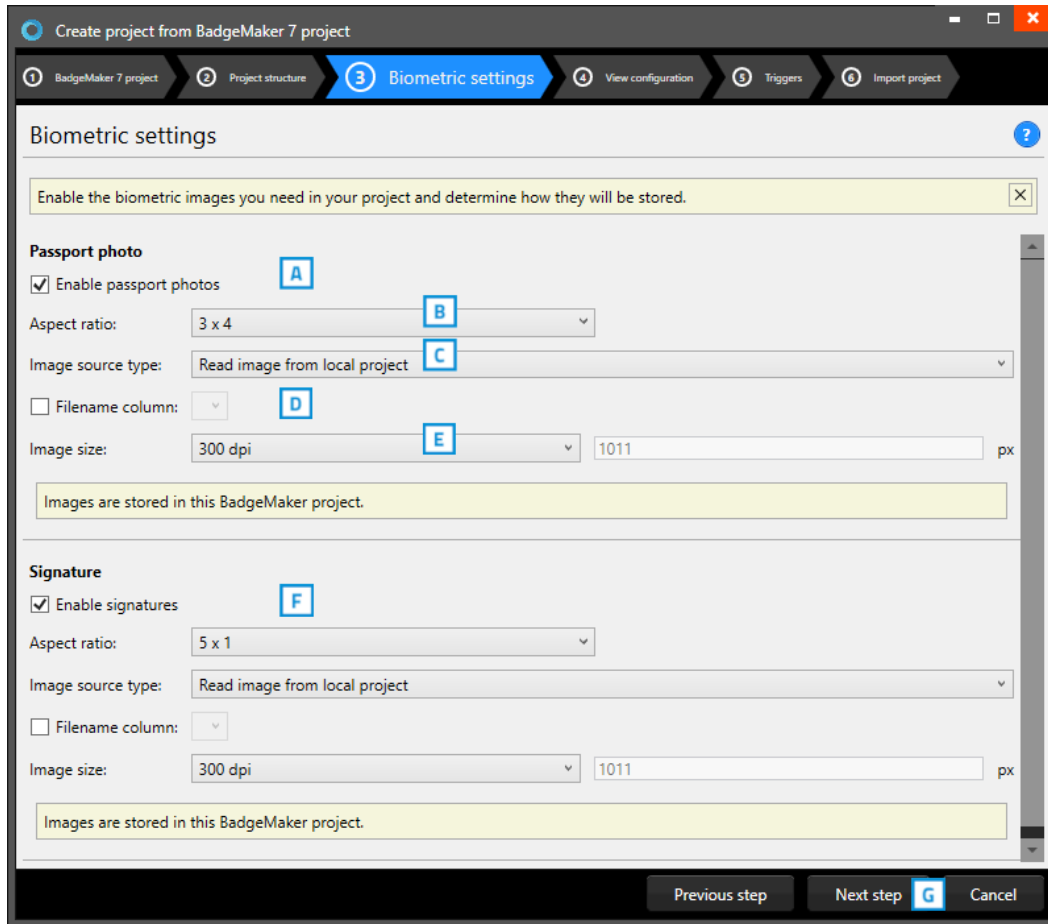

Fig. Example of step 3. New project: Biometric settings

1. The box for passport photos makes photos visible in the project and enables you to add photos.
2. After checking the box, you can determine the ratio of the photo.
3. Select how and where photos will be saved within your project.
4. Check this box if you want to use data columns to represent the filename.
5. Here you can select what size the photos need to be saved as within your project.
6. The box for the signature makes signatures visible in the project and enables you to add signatures. The signature section works the same as the Passport photo section above.
7. Click on the “Next step” button to go to step 4 and configure the view configuration.

#### 4. View configuration

During step 4 you can select the default configuration or adjust the setup for Detailed and Gallery view.

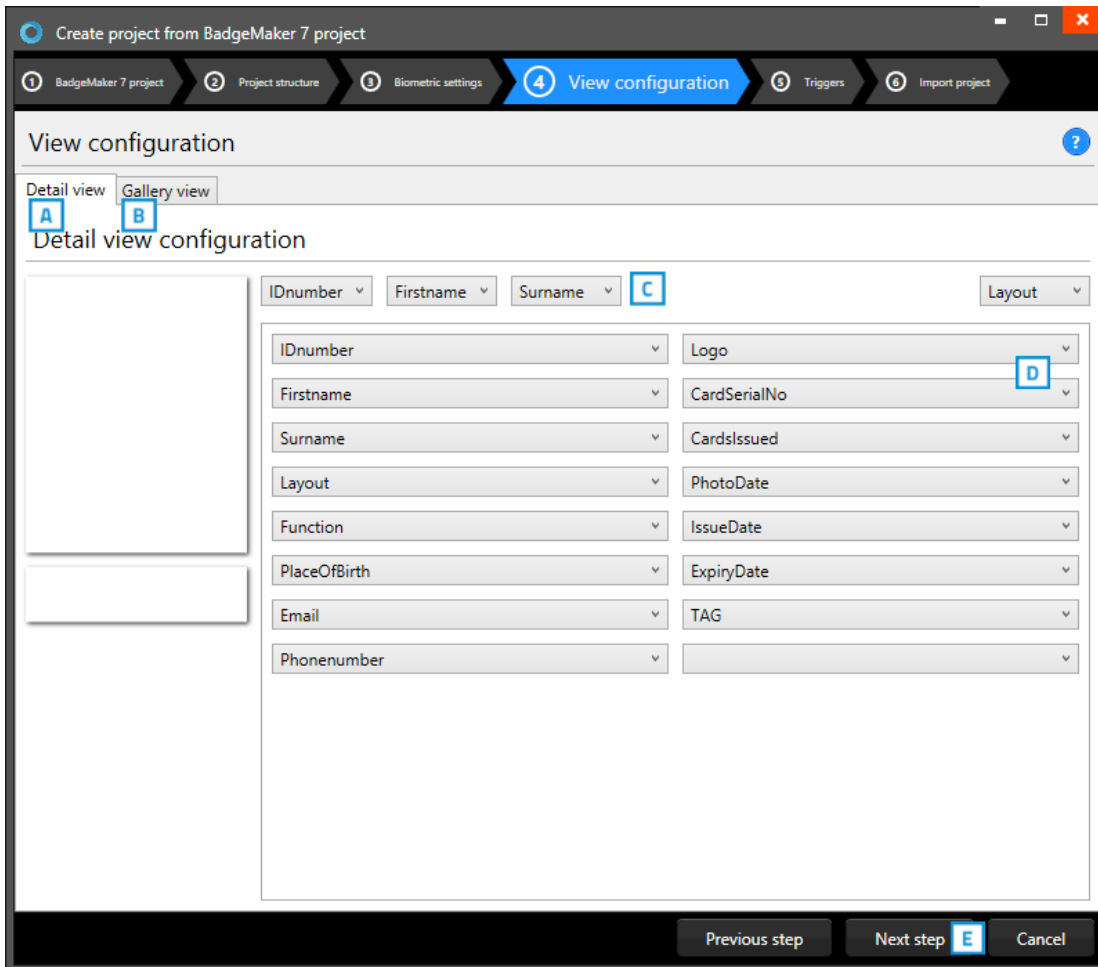

Fig. Example of step 4. New project: View configuration

- A. Tab to configure detailed view showing specific cardholders' information.
- B. Tab to configure gallery view showing cardholders photos.
- C. Setup the title for the detailed view.
- D. Setup the information that will be shown in the detailed view.
- E. Click on the "Next step" button to go to step 5 and add triggers to the project.

## 5. Triggers

Step 5 allows you to setup triggers for your project. Triggers can be used to automatically change data in your project on a certain condition or event.

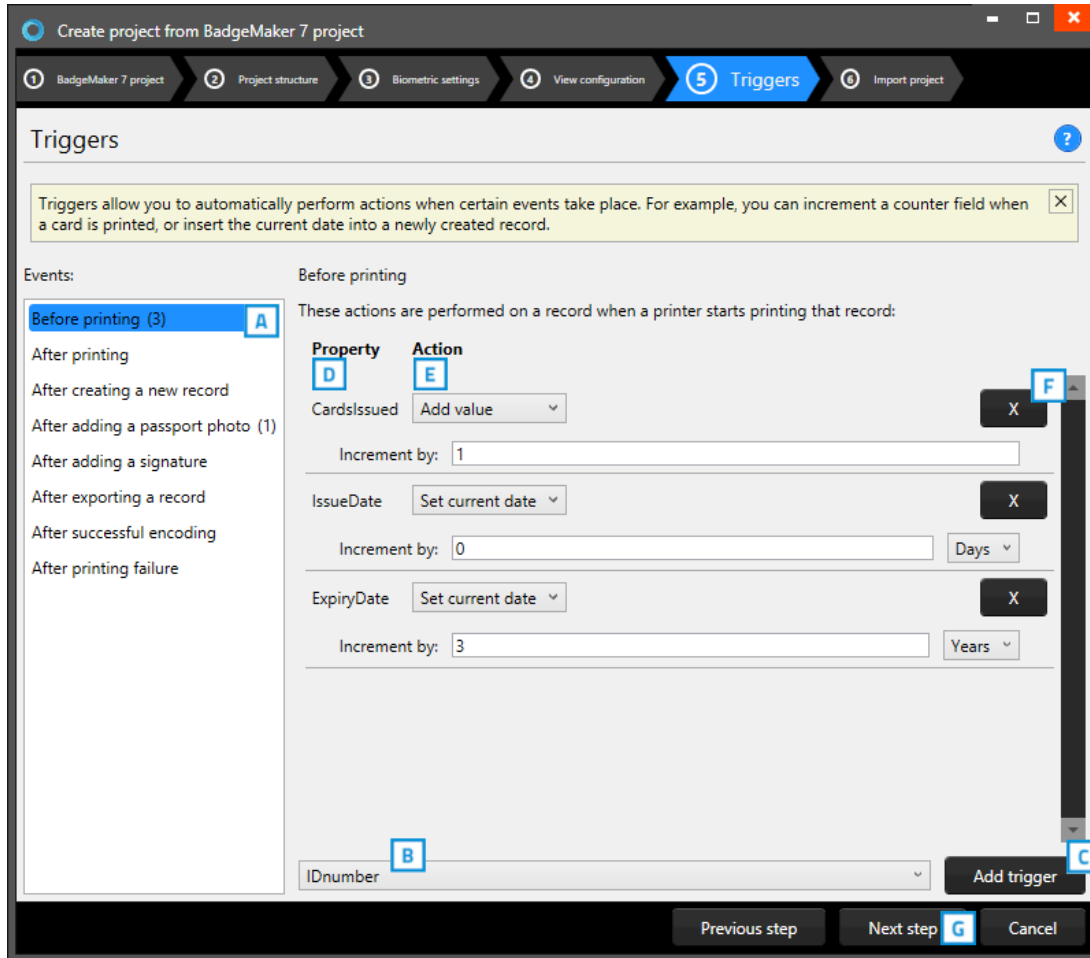

Fig. Example of step 5. New project: Triggers

- A. Select one of the events from this list and add specific triggers. BadgeMaker Identity will automatically wait for the event to occur before performing the action that is linked to the trigger.
- B. All data columns of the new project are listed. Select one of the columns to link a trigger action to it.
- C. Click on the “Add trigger” button to add the trigger to the data column and specify the trigger with events and actions.
- D. The property shows you the selected data column.
- E. Select the action you want to connect to the data column from the drop-down menu and define the action.
- F. Click on the “X” button to delete a trigger from an event.
- G. Click on the “Next step” button to go to step 6 and create the project.

Define the action that is performed once the event has been met. Some actions are only available for specific columns (for example, incrementing number values can only be done on Number type columns). All changes need to be saved before they become active. Understand that triggers might cause your original data to change, so make sure no vital data is lost when working with triggers.

## 6. Import Project

- A. Step 6 will create the new project imported from a BadgeMaker 7 file as soon as you click on the “Create project” button.
- B. Click on the “Previous step” button to make any changes before creating the project.

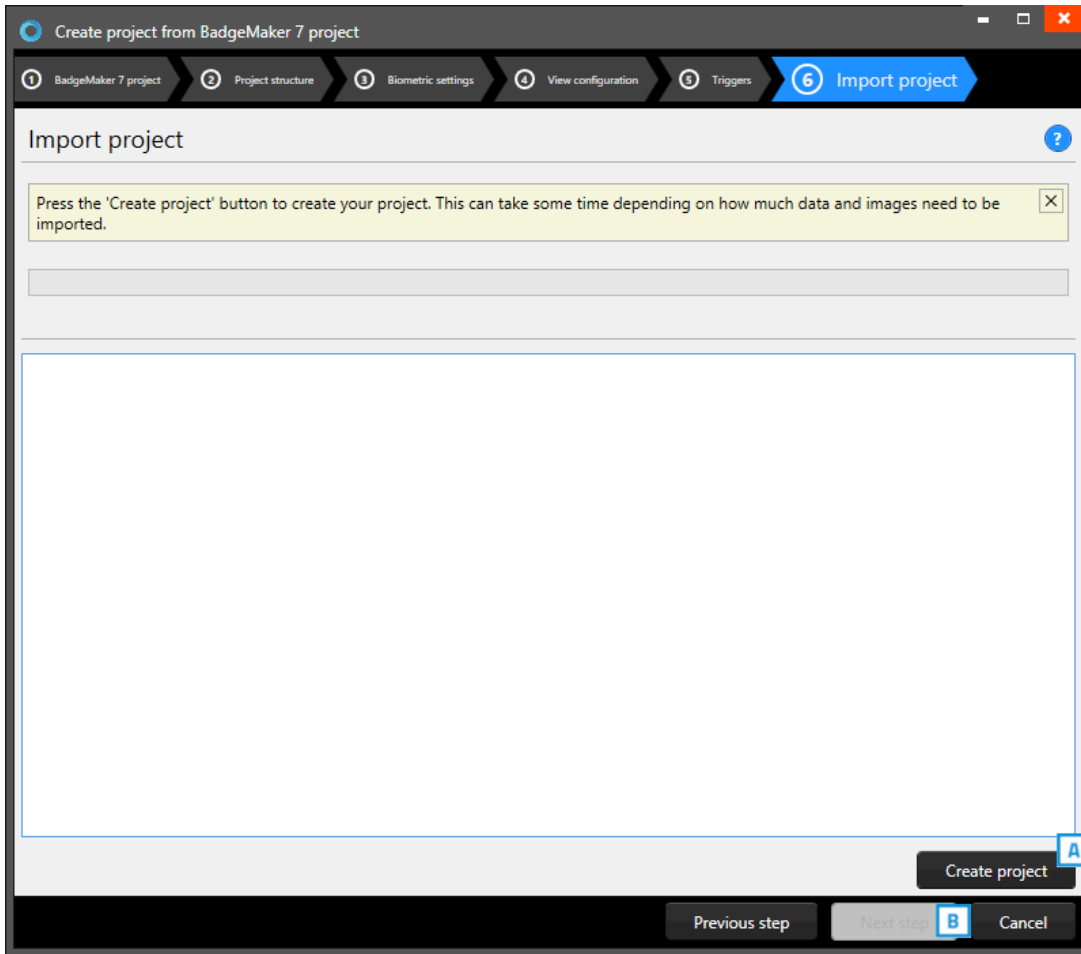

Fig. Example of step 6. New project: import BadgeMaker 7 project.

## F. New Project from IDPro 7 Project

### 1. Select IDPro 7 Project

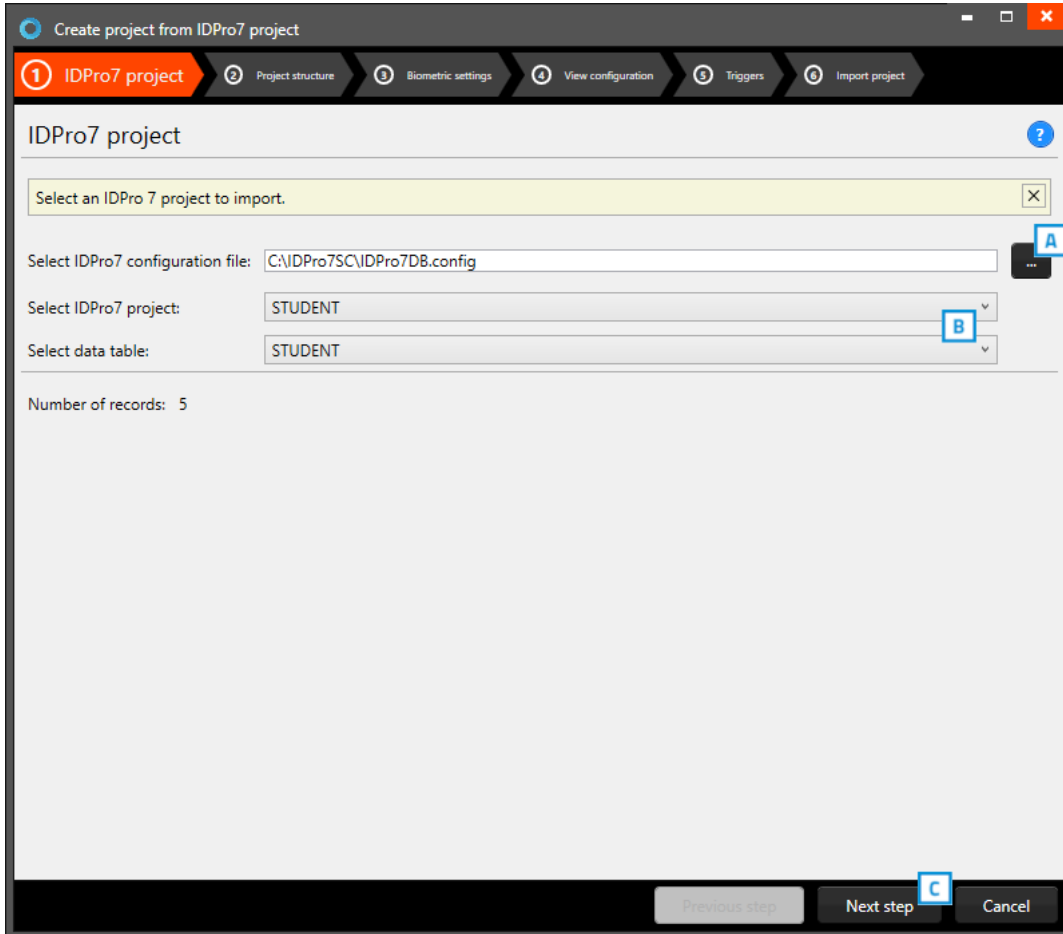
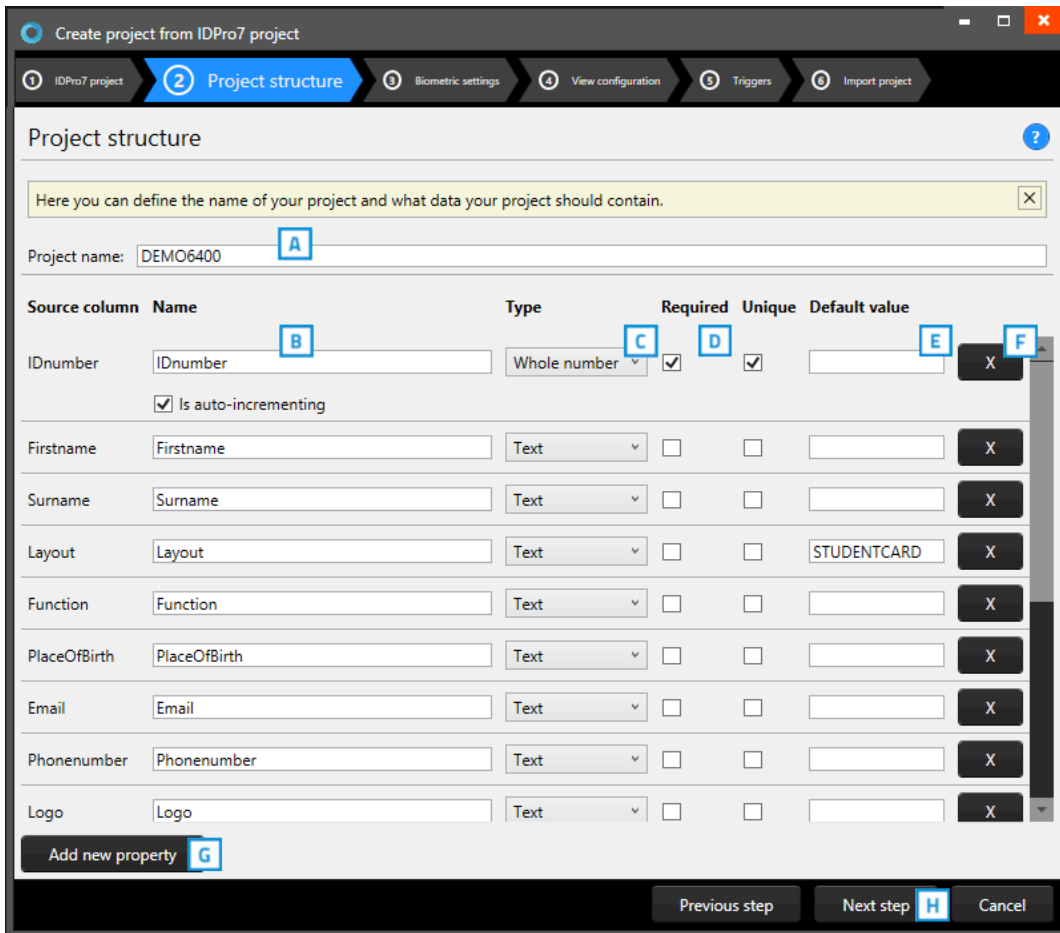

Fig. Example of step 1. New project: Select IDPro 7 Project

- A. Click on this button to select the IDPro 7 configuration file from your computer.
- B. Click on the drop-down menu to select the IDPro 7 project and the table from your computer.
- C. Click on the “Next step” button to go to step 2 and check or adjust the project structure.

## 2. Project structure



Project structure

Here you can define the name of your project and what data your project should contain.

Project name: DEMO6400

Source column	Name	Type	Required	Unique	Default value	
IDnumber	IDnumber	Whole number	<input checked="" type="checkbox"/>	<input checked="" type="checkbox"/>		X
	<input checked="" type="checkbox"/> Is auto-incrementing					
Firstname	Firstname	Text	<input type="checkbox"/>	<input type="checkbox"/>		X
Surname	Surname	Text	<input type="checkbox"/>	<input type="checkbox"/>		X
Layout	Layout	Text	<input type="checkbox"/>	<input type="checkbox"/>	STUDENTCARD	X
Function	Function	Text	<input type="checkbox"/>	<input type="checkbox"/>		X
PlaceOfBirth	PlaceOfBirth	Text	<input type="checkbox"/>	<input type="checkbox"/>		X
Email	Email	Text	<input type="checkbox"/>	<input type="checkbox"/>		X
Phonenumber	Phonenumber	Text	<input type="checkbox"/>	<input type="checkbox"/>		X
Logo	Logo	Text	<input type="checkbox"/>	<input type="checkbox"/>		X

Add new property

Previous step Next step Cancel

Fig. Example of step 2. New project: Project data columns.

- A. Enter the name of your new project.
- B. Enter the column name.
- C. Set the data type. Select if the data are number or text for example. The following types of database fields are supported:
  - Whole Number, when selecting this type, you can select 'auto-increment'. When a new record is created the number will be the highest number in the Project increased by 1.
  - Text
  - Decimal number
  - Option List, when this list type is selected you can add and delete the list values from the list that is presented for this database field.
- D. Check these boxes if the field needs to be "Required" and/or "Unique".
- E. With the default input field, you can add a standard value to your data field, existing empty fields and new records will automatically display the default value you add to this data field.
- F. Click on the "X" button to delete a data field from the project structure setup.
- G. Click on the "Add new property" button and add and describe the data field names you want to use in your new project.
- H. Click on the "Next step" button to go to step 3.

### 3. Biometric settings

During step 3 you can enable the biometric images you need in your project and determine how they will be stored.

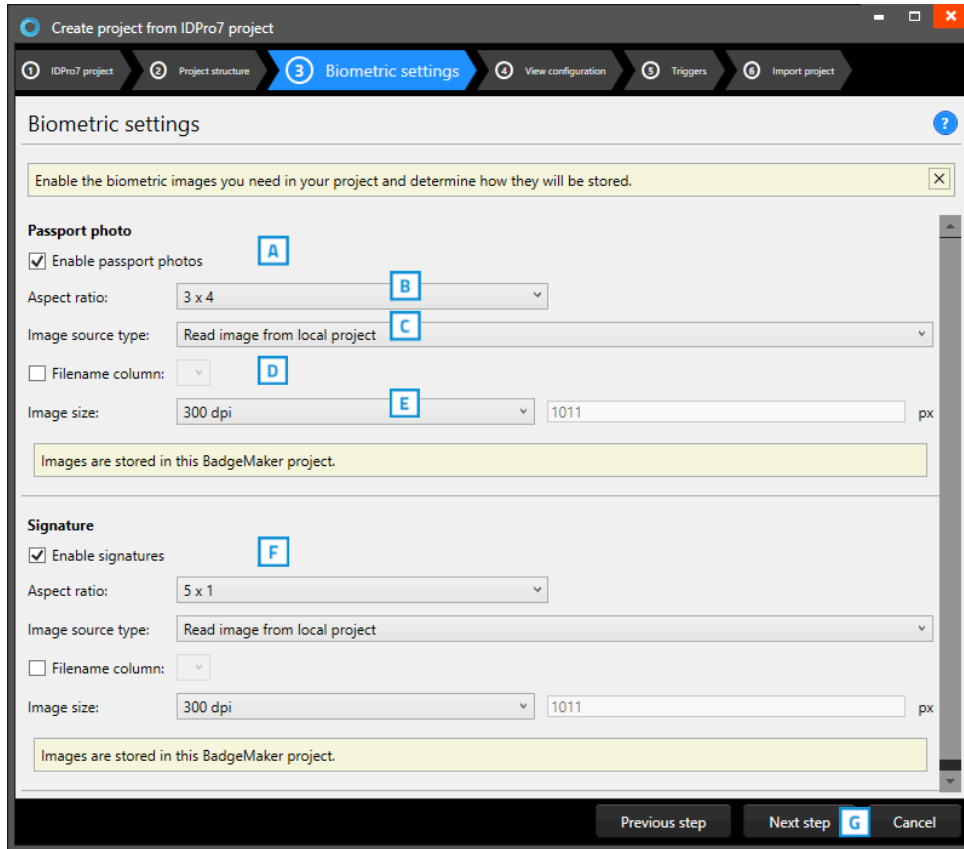

Fig. Example of step 3. New project: Biometric settings

- A. The box for passport photos makes photos visible in the project and enables you to add photos.
- B. After checking the box, you can determine the ratio of the photo.
- C. Select how and where photos will be saved within your project.
- D. Check this box if you want to use data columns to represent the filename.
- E. Here you can select what size the photos need to be saved as within your project.
- F. The box for the signature makes signatures visible in the project and enables you to add signatures. The signature section works the same as the passport photo section above.
- G. Click on the “Next step” button to go to step 4 and configure the detailed and gallery



#### 4. View configuration

During step 4 you can select the default configuration or adjust the setup for Detailed and Gallery view.

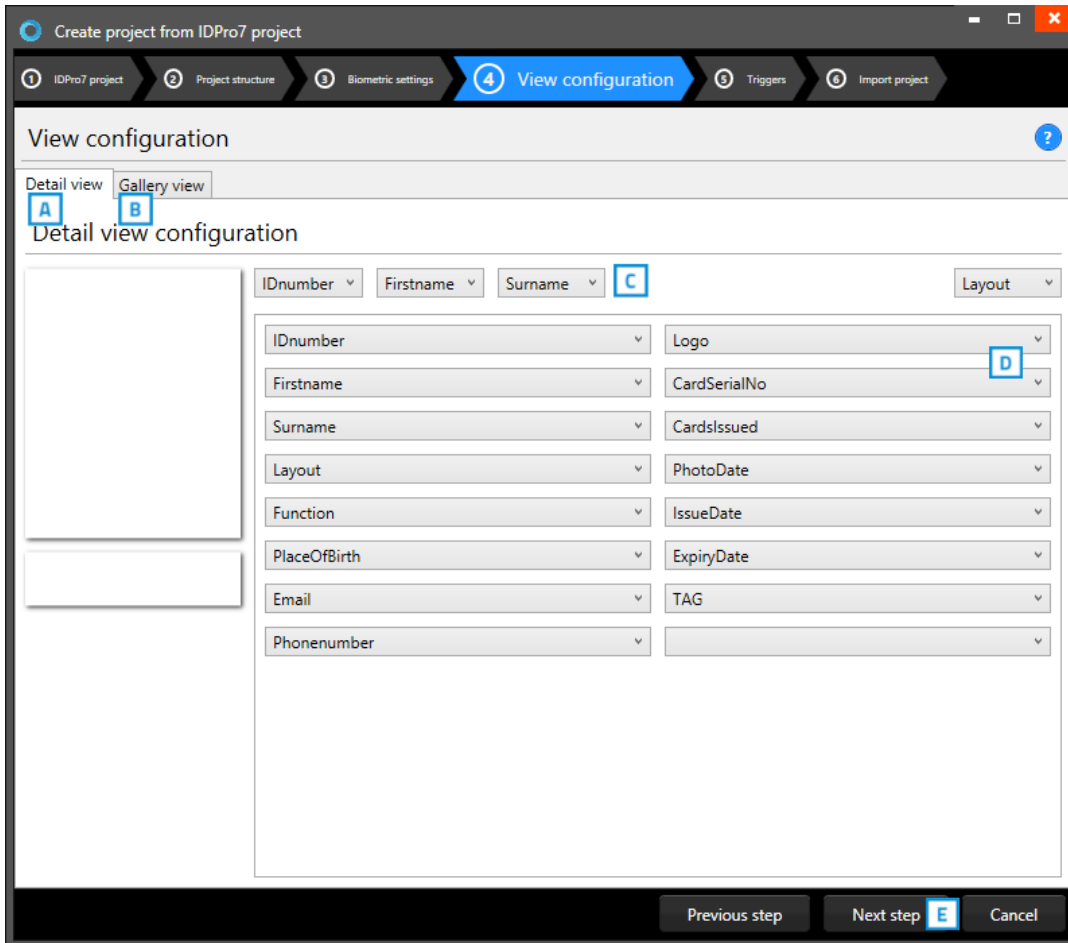

Fig. Example of step 4. New project: View configuration

- A. Tab to configure Detailed view showing specific cardholders' information.
- B. Tab to configure Gallery view showing cardholders photos.
- C. Setup the title for the detailed view.
- D. Setup the information that will be shown in the detailed view.
- E. Click on the "Next step" button to go to step 5 and add triggers to the project.

## 5. Triggers

Step 5 allows you to setup triggers for your project. Triggers can be used to automatically change data in your project on a certain condition or event.

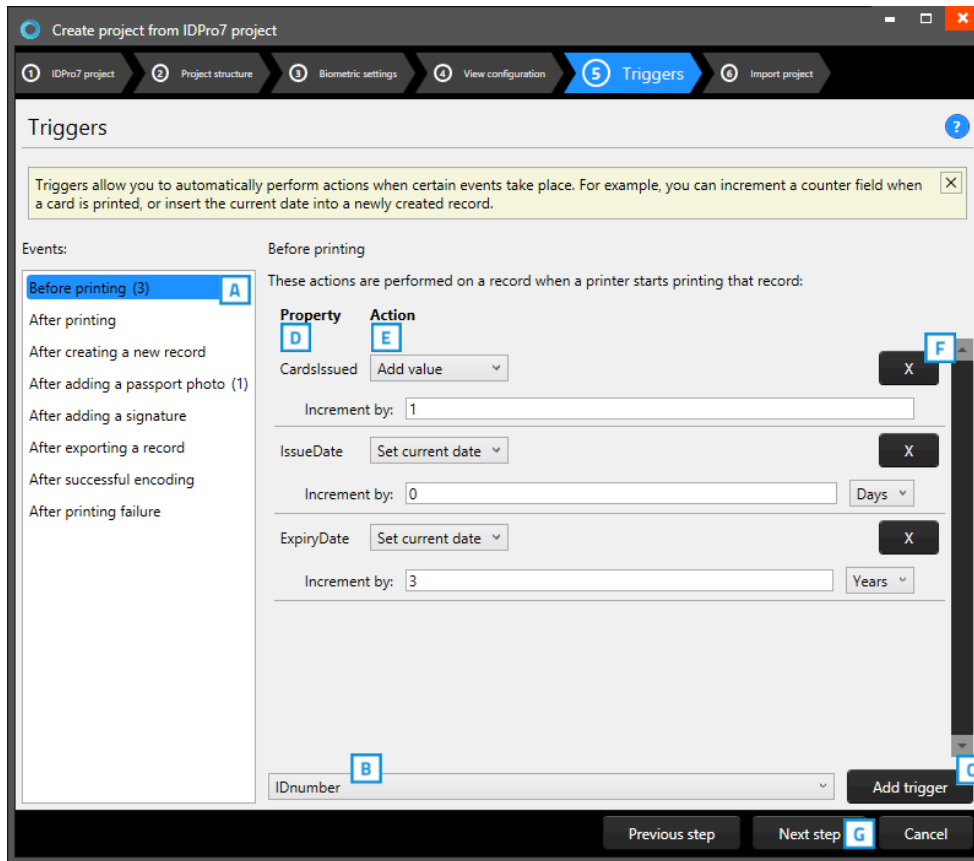

Fig. Example of step 5. New project: Triggers

- A. Select one of the events from this list and add specific triggers. BadgeMaker Identity will automatically wait for the event to occur before performing the action that is linked to the trigger.
- B. All data columns of the new project are listed. Select one of the columns to link a trigger action to it.
- C. Click on the “Add trigger” button to add the trigger to the data column and specify the trigger with events and actions.
- D. The property shows you the selected data column.
- E. Select the action you want to connect to the data column from the drop-down menu and define the action.
- F. Click on the “X” button to delete a trigger from an event.
- G. Click on the “Next step” button to go to step 6 and create the project.

Define the action that is performed once the event has been met. Some actions are only available for specific columns (for example, incrementing number values can only be done on Number type columns). All changes need to be saved before they become active. Understand that triggers might cause your original data to change, so make sure no vital data is lost when working with triggers.

**6. Import Project**

- A. Step 6 will create the new project imported from an IDPro7 file as soon as you click on the “[Create project](#)” button.
- B. Click on the “[Previous step](#)” button to make any changes before creating the project.

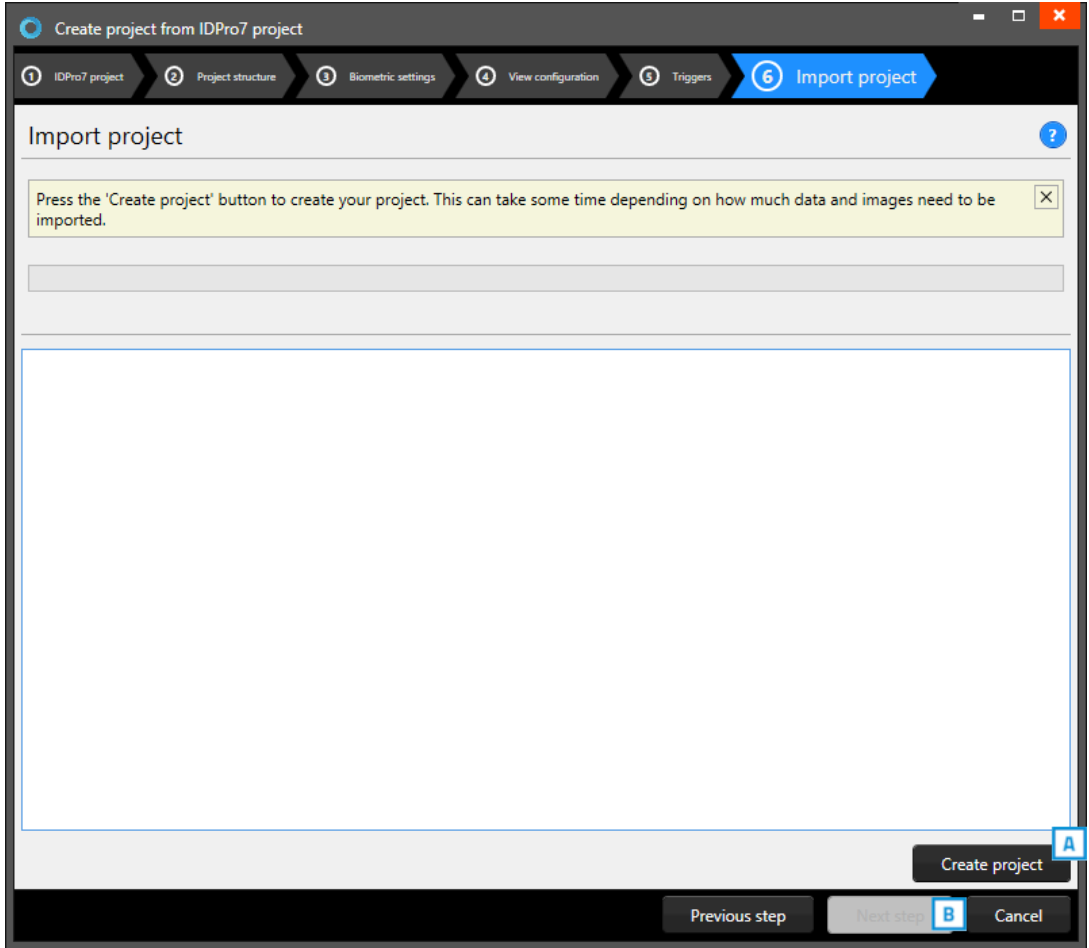

Fig. Example of step 6. New project: import BadgeMaker 7 project.

## Open Project

To open an existing project, select the “Open” link or button. All available existing projects are displayed, and you can select the project that needs to be opened.

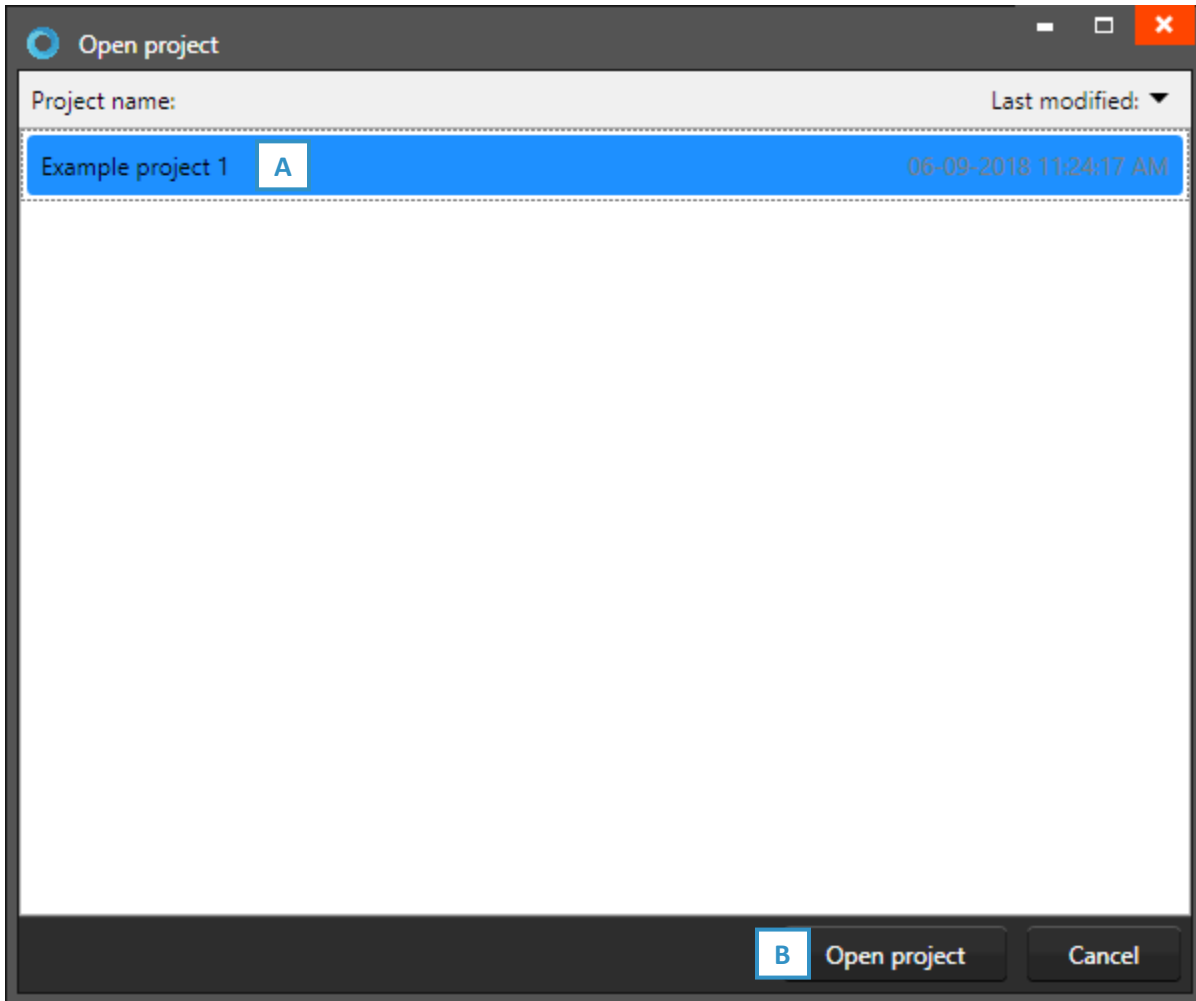

Fig. Example of the Open existing project pop-up window.

- A. Select one of the existing projects.
- B. Click on the “Open project” button.

## Import Data

You can import data by using an Excel/CSV, BadgeMaker 7 file, ID Pro 7 project or an XML file.



Fig. Example of the import data pop-up window.

## A. Import Excel or CSV data

### 1. Data source

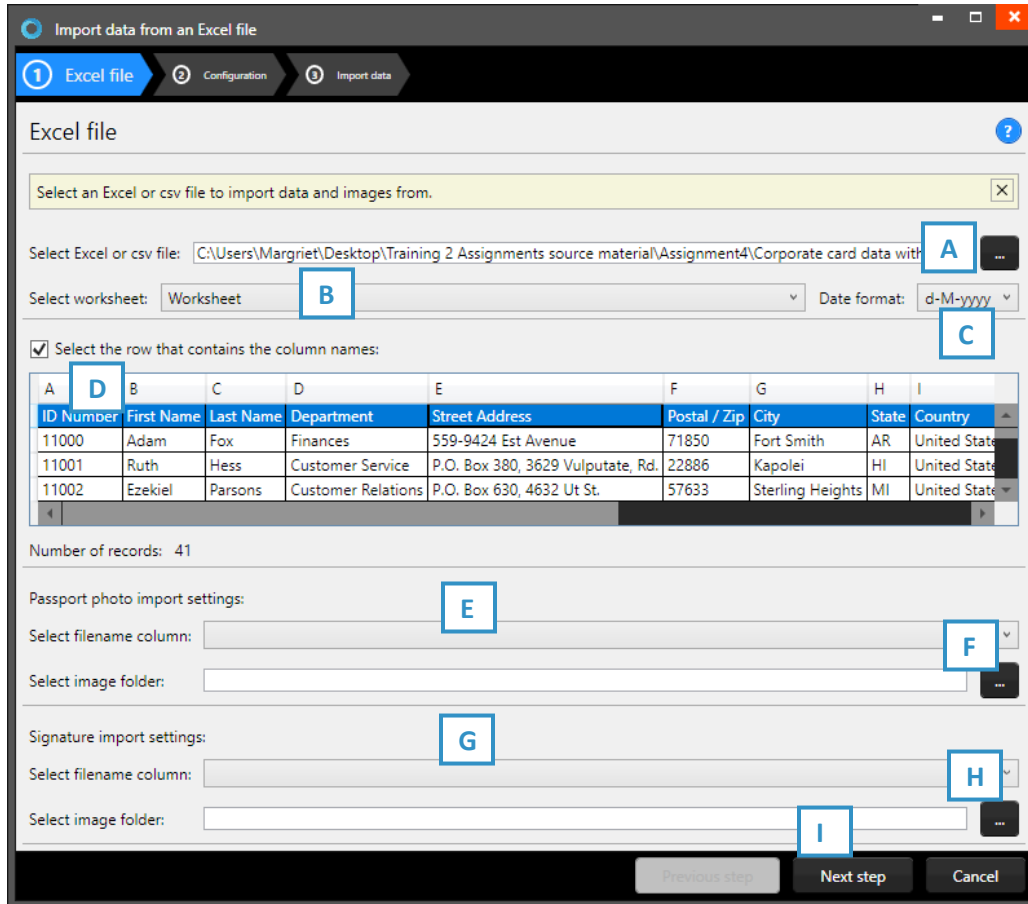

Import data from an Excel file

1 Excel file 2 Configuration 3 Import data

Excel file ?

Select an Excel or csv file to import data and images from. X

Select Excel or csv file: C:\Users\Margriet\Desktop\Training 2 Assignments source material\Assignment4\Corporate card data with A ...

Select worksheet: Worksheet B Date format: d-M-yyyy C

Select the row that contains the column names:

A	B	C	D	E	F	G	H	I
ID Number	First Name	Last Name	Department	Street Address	Postal / Zip	City	State	Country
11000	Adam	Fox	Finances	559-9424 Est Avenue	71850	Fort Smith	AR	United States
11001	Ruth	Hess	Customer Service	P.O. Box 380, 3629 Vulputate, Rd.	22886	Kapolei	HI	United States
11002	Ezekiel	Parsons	Customer Relations	P.O. Box 630, 4632 Ut St.	57633	Sterling Heights	MI	United States

Number of records: 41

Passport photo import settings: E

Select filename column: F

Select image folder: ...

Signature import settings: G

Select filename column: H

Select image folder: I

Previous step Next step Cancel

Fig. Example of the import data pop-up window.

- A. Click on this button and select the Excel/CSV file you want to import. Select the worksheet you want to use from the drop-down menu below.
- B. Select the worksheet.
- C. Set the date format used in the Excel file.
- D. Select the row that contains the column names.
- E. Select the column that connects with the unique photo names (for example: ID number or index).
- F. Select the folder that contains the cardholders' photos.
- G. Select the column that connects with the unique signature names (for example: ID number or index).
- H. Select the folder that contains the signature images.
- I. Click on the "Next step" button to continue to the second step.

## 2. Configuration

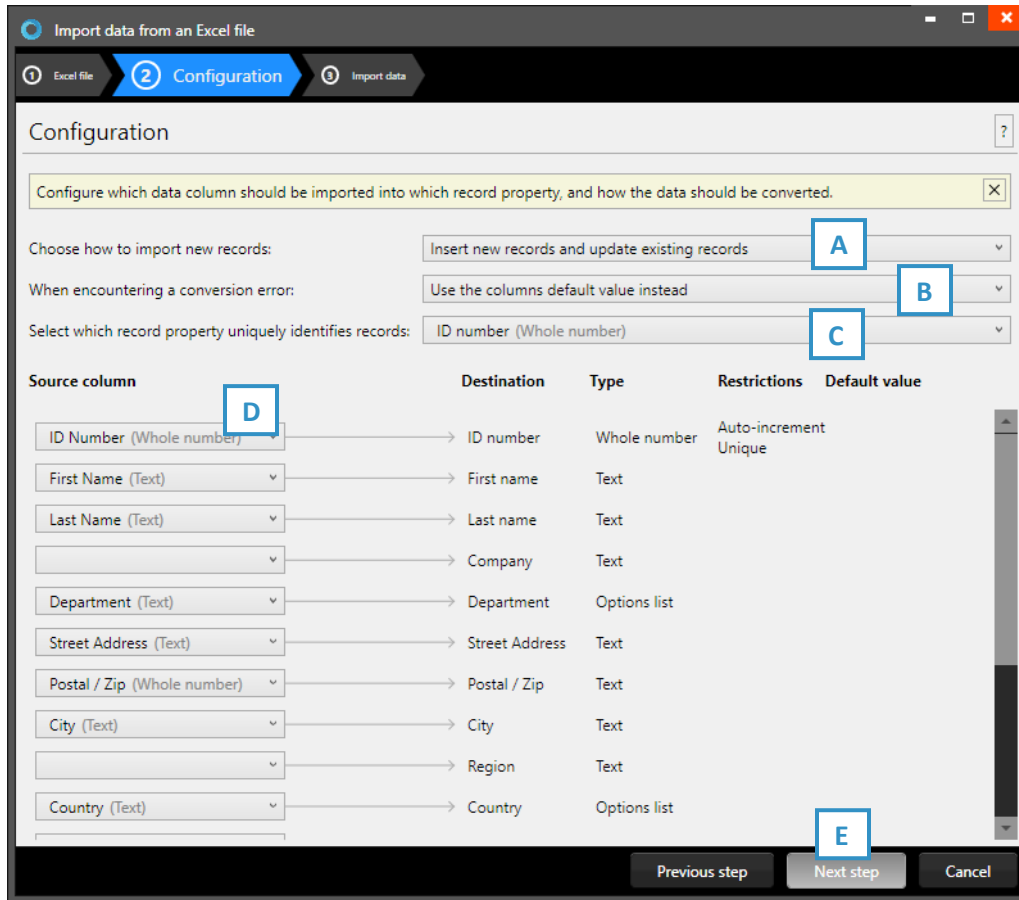

Fig. Example of the import Excel/CSV data pop-up window.

- A. Check this box to only import new records, existing records will not be overwritten.
- B. Select what happens when encountering a conversion error.
- C. Select one of the fields of the excel data which uniquely identifies data in the data source.
- D. Connect the source columns with the destination columns, BadgeMaker has already connected the columns with similar names.
- E. Click on the “Next step” button to continue to import the data.

### 3. Import data

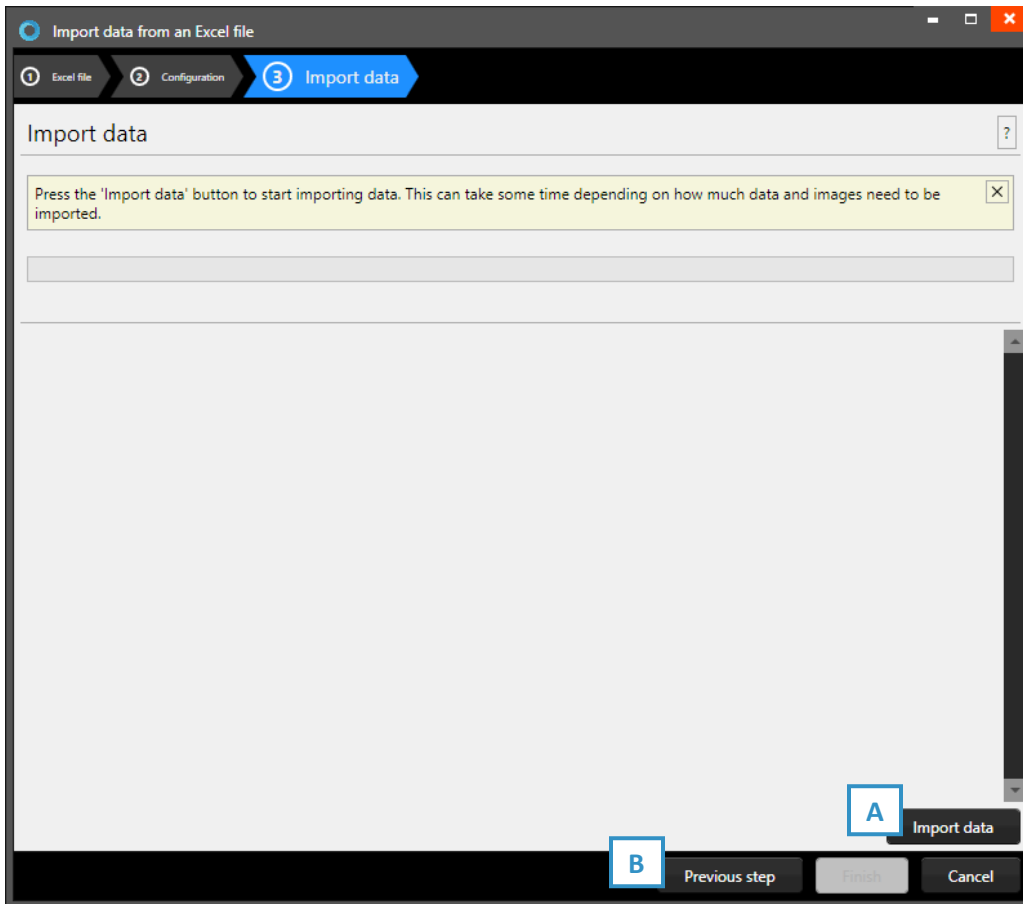

Fig. Example of step 3. Import data

Step 3. is processing the import of data.

- A. Click on the “Import data” button to start working with the imported data from your Excel file.
- B. Click on the “Previous step” button to make any changes before creating the project.



## B. Import BadgeMaker 7 data

### 1. Data source

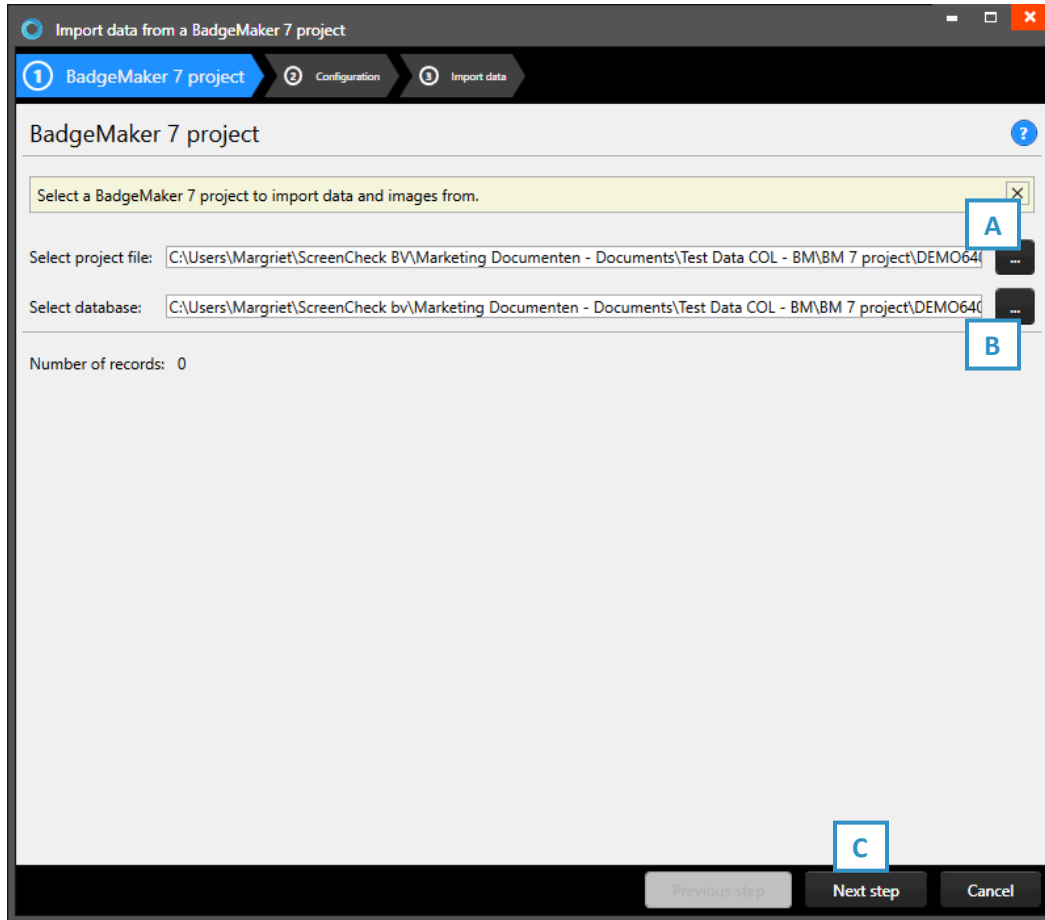

Fig. Example of the import data pop-up window.

- A. Click on this button to select the BadgeMaker 7 project from your computer.
- B. Click on this button to select the BadgeMaker 7 database from your computer.
- C. Click on the “Next step” button to go to step 2.

## 2. Configuration

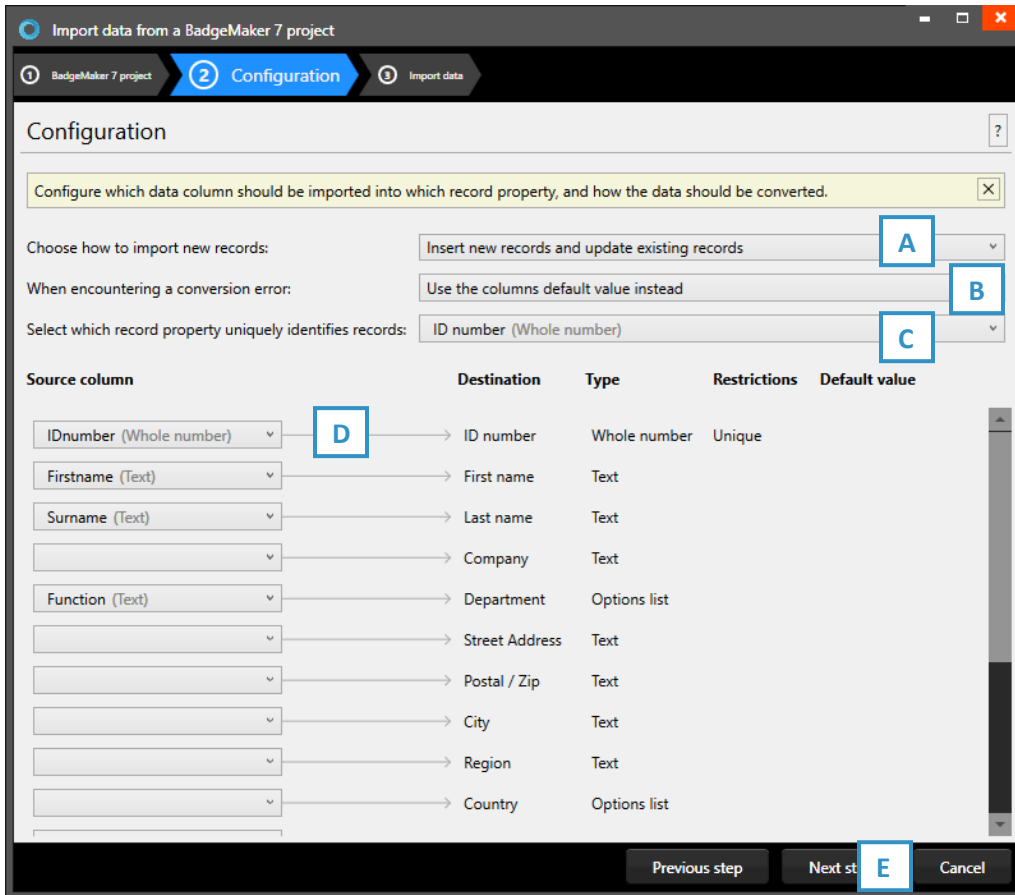

Fig. Example of the import of BadgeMaker 7 data pop-up window.

- A. Choose how to import new records, select one of the three ways.
- B. Select what happens when encountering a conversion error.
- C. Select one of the fields of the excel data which uniquely identifies data in the data source.
- D. Connect the source columns with the destination columns, BadgeMaker has already connected the columns with similar names.
- E. Click on the “Next step” button to continue to import the data.

### 3. Import data

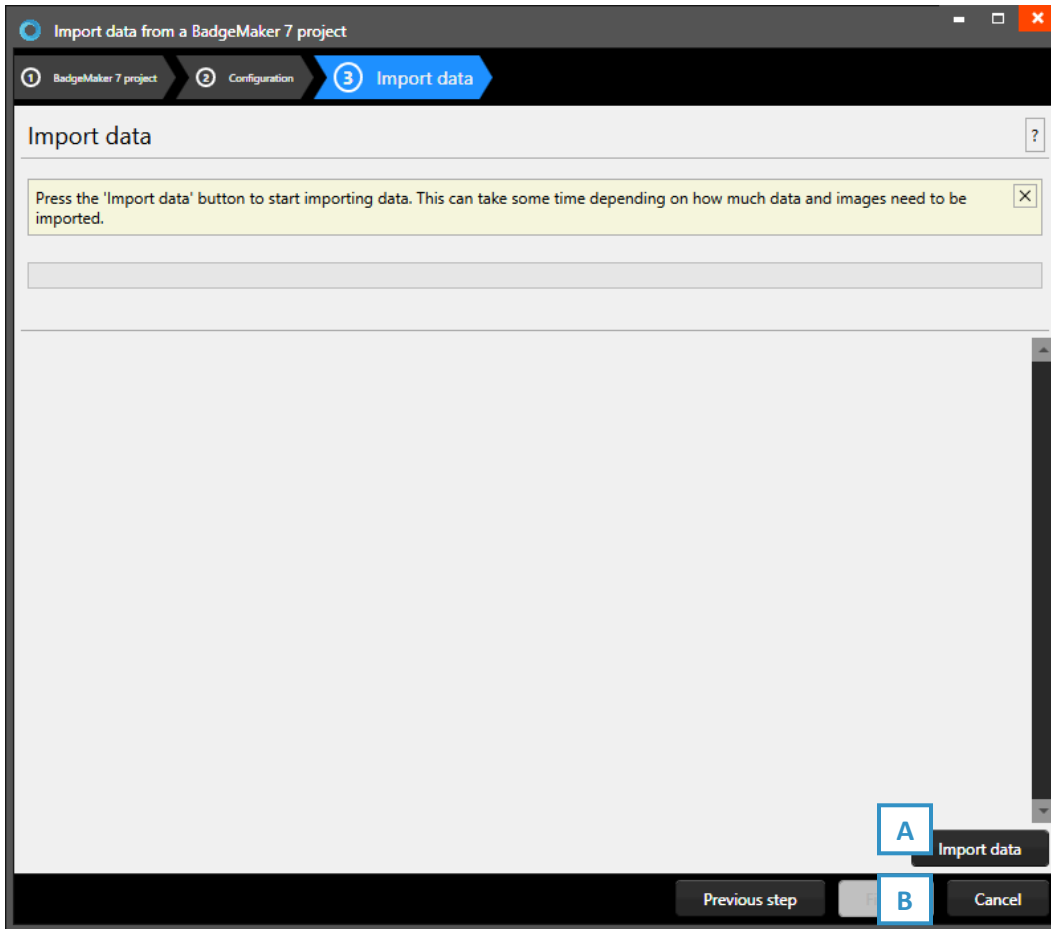

Fig. Example of step 3. Import data.

Step 3 is processing the import of data.

- A. Click on the “Import data” button to import the data.
- B. Click on the “Finish” to start working with the imported data from your Badgemaker 7.

## C. Import IDPro 7 data

### 1. Data source

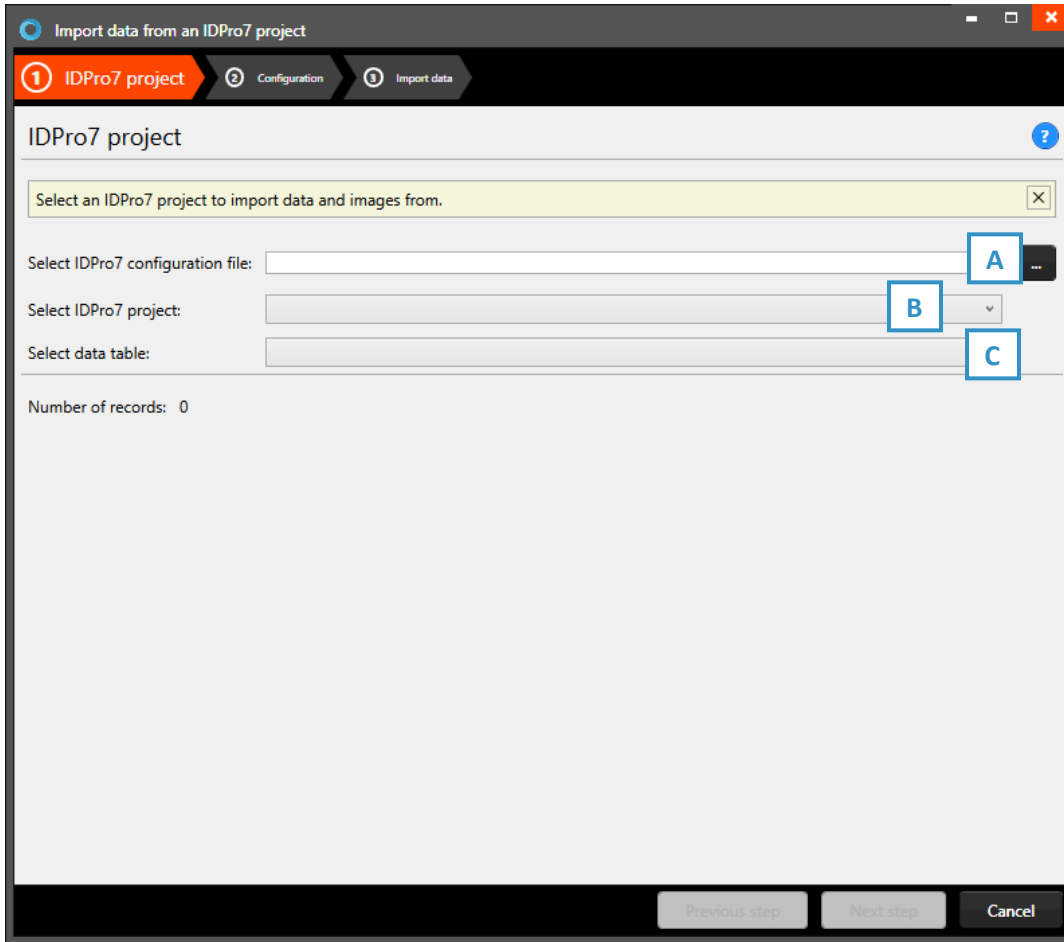

Fig. Example of the import data pop-up window.

- A. Click on this button to select the IDPro 7 configuration file from your computer.
- B. Click on the drop-down menu to select the IDPro 7 project from your computer.
- C. Click on the “Next step” button to go to step 2.

## 2. Configuration

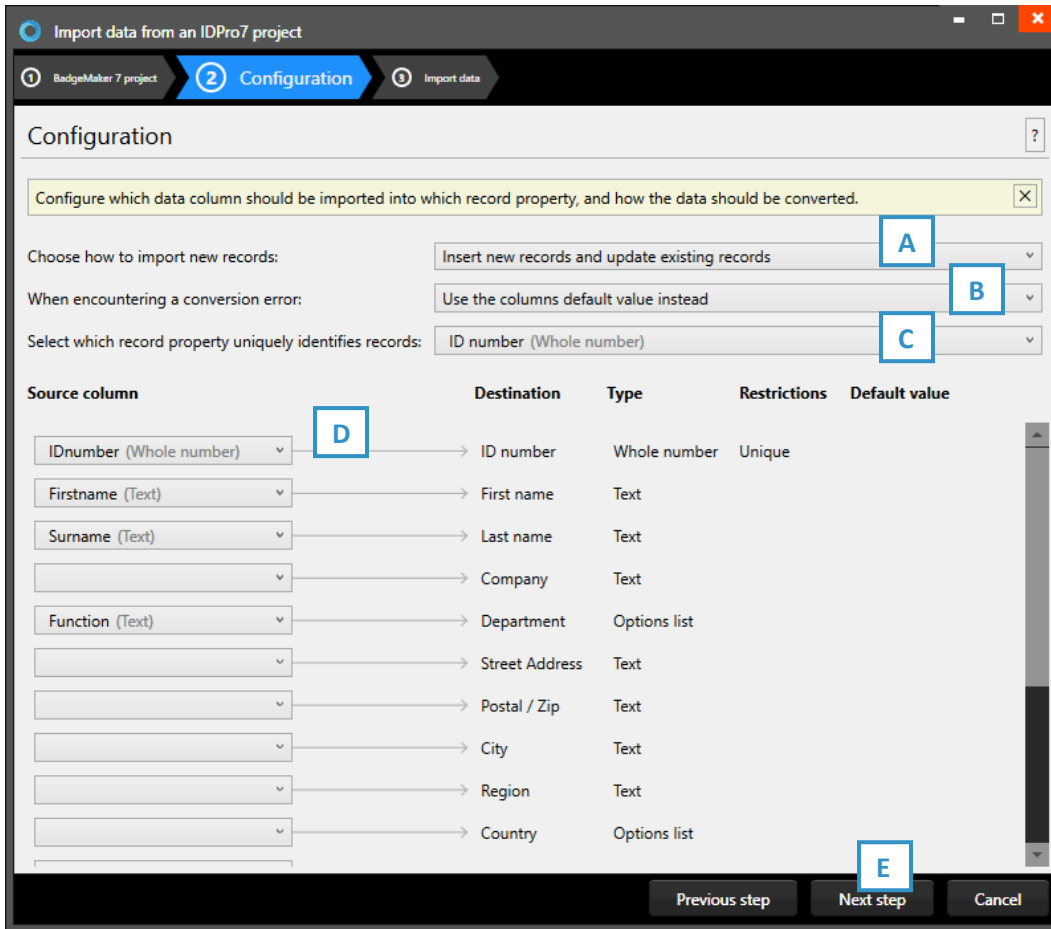

Fig. Example of the import of IDPro7 data pop-up window.

- A. Choose how to import new records, select one of the three ways.
- B. Select what happens when encountering a conversion error.
- C. Select one of the fields of excel data which uniquely identifies data in the data source.
- D. Connect the source columns with the destination columns, BadgeMaker has already connected the columns with similar names.
- E. Click on the “Next step” button to continue to import the data.

### 3. Import data

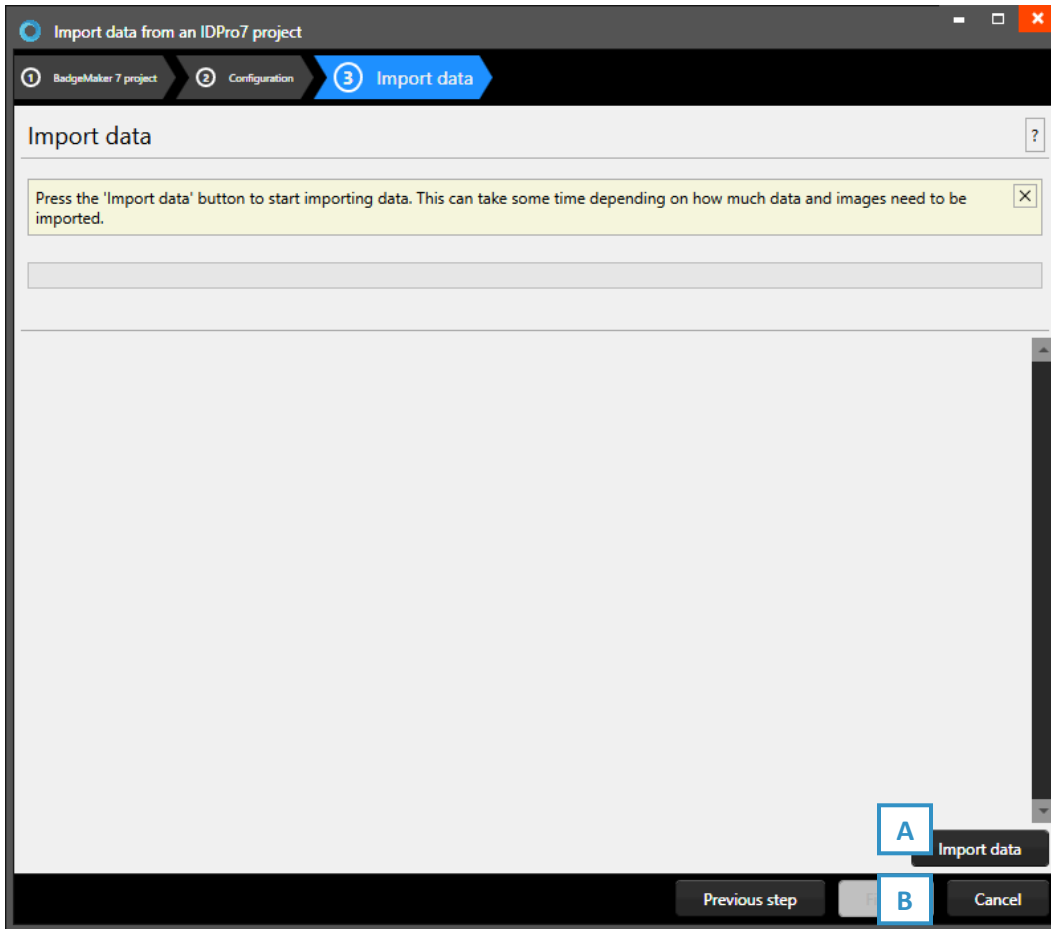

Fig. Example of step 3. Import data.

Step 3. is processing the import of data.

- A. Click on the “Import data” button to import the data.
- B. Click on the “Finish” to start working with the imported data from your IDPro 7.

## D. Import XML data

Import data and base64-encoded images from XML files.

### 1. Data source

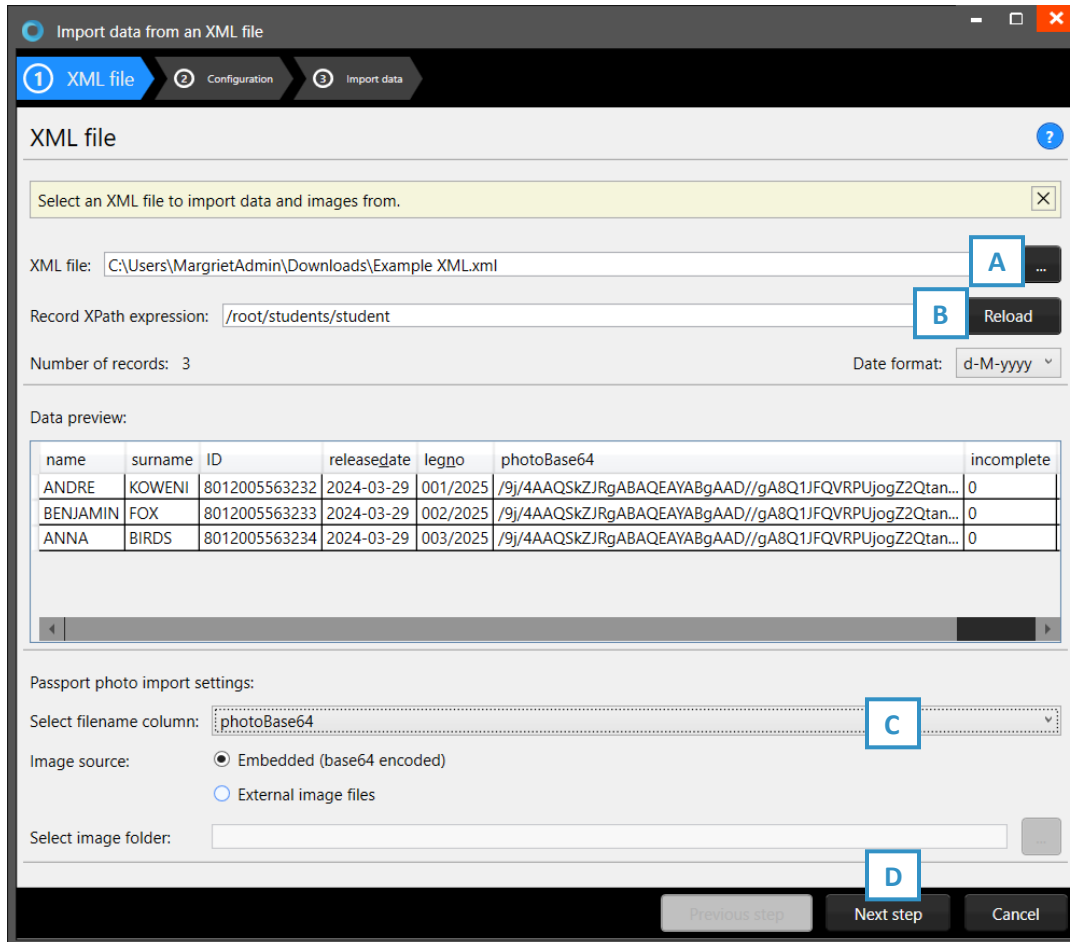

Fig. Example of the import data pop-up window Step 1. Select the XML file.

- A. Click on this button to select the XML file from your computer.
- B. Record XPath expression (XPath is a sub-language of XSL specifically designed to uniquely identify or address parts of a source XML document.) By using XPath expressions, you can search through an XML document and extract information from its nodes, such as elements or attributes. When selecting an XML file this usually is filled out automatically.
- C. Select the column that contains the embedded images in the XML file. These photos will also be imported into the BadgeMaker Project. It is also possible to select images from an external file.
- D. Click on the “Next step” button to go to step 2.

## 2. Configuration

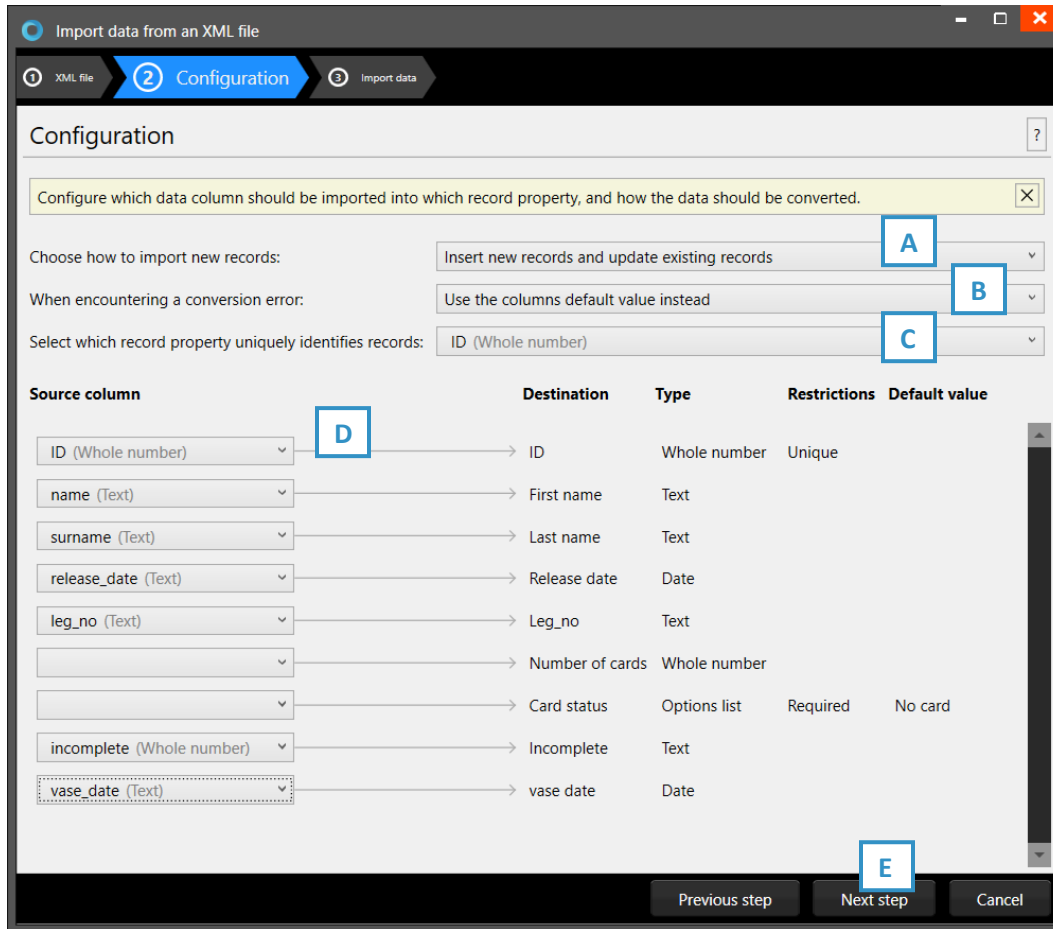

Fig. Example of the import of XML data pop-up window: Step 2. Configuration.

- A. Choose how to import new records, select one of the three options:
  - Only import new records (Existing records won't be updated)
  - Only update existing records (new records won't be added)
  - Insert new records and update existing records
- B. Select what happens when encountering a conversion error, choose one of the three options:
  - Use the columns default value instead
  - Don't import the erroneous row
  - Stop importing
- C. Select the column which uniquely identifies data in the data source.
- D. Connect the source columns with the destination columns, BadgeMaker has already connected the columns with similar names.
- E. Click on the "Next step" button to continue to import the data.



### 3. Import data

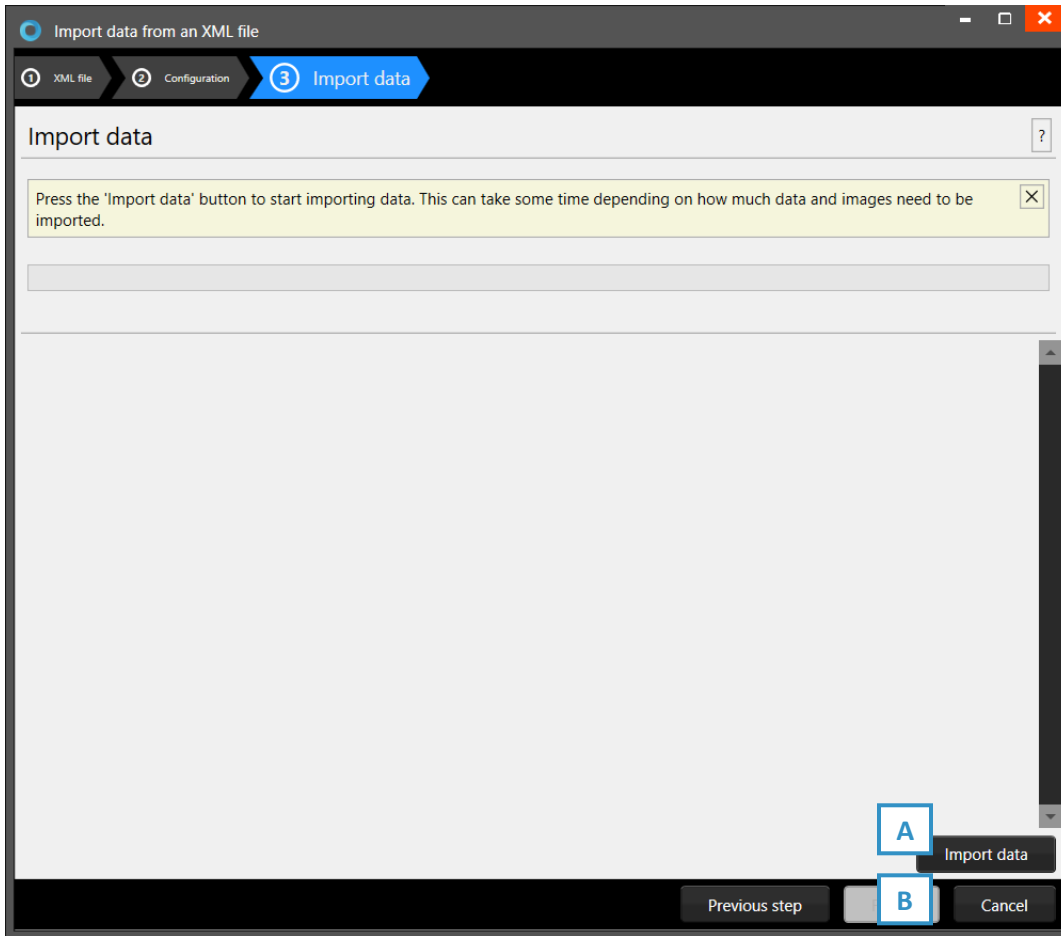

Fig. Example of step 3. Import data.

Step 3. is processing the import of data.

- C. Click on the “Import data” button to import the data.
- D. Click on the “Finish” to start working with the imported data from your XML file.

## Import photos

At step 1, biometric data, you can import passport photos and/or signature images.

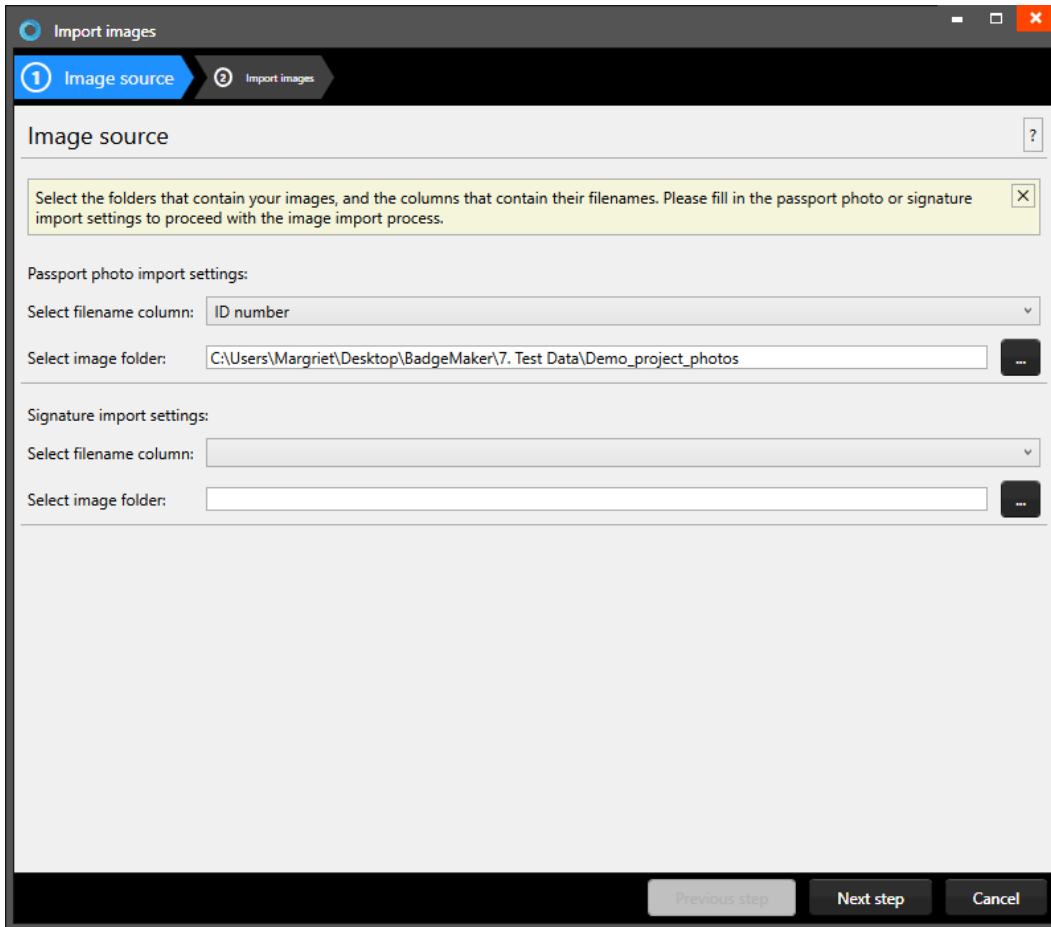
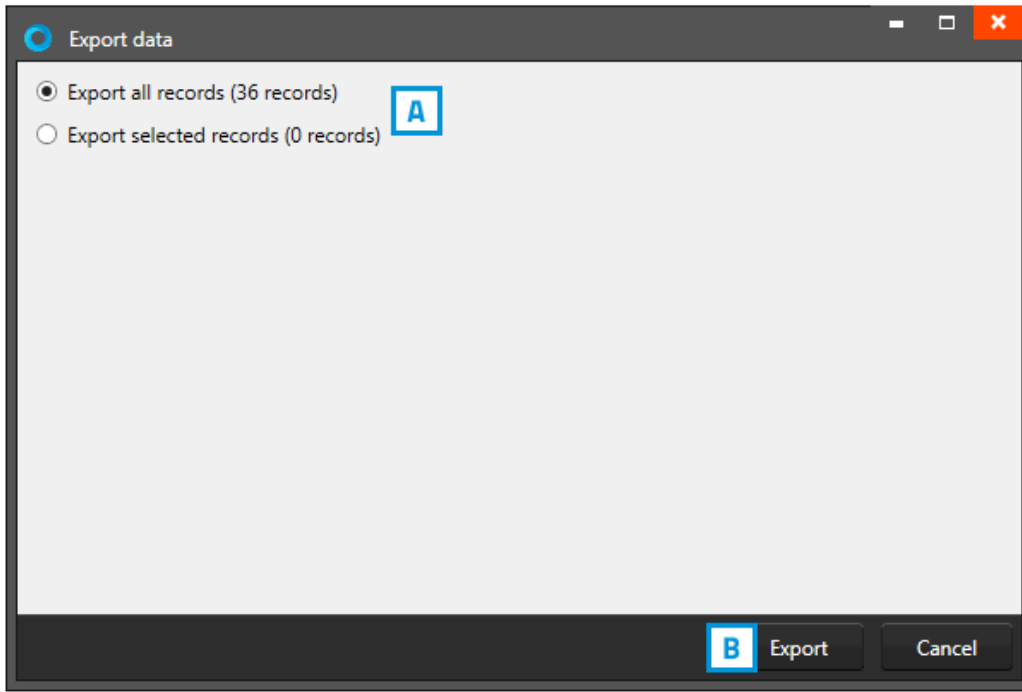

Fig. Example of importing biometric data.

- A. Select the data field that contains unique data, like photo- and/or signature names.
- B. Click on this button and select the photo- and/or signatures folder you want to import from. The images need to have a unique name that can be connected to one of the unique fields.
- C. Click on the “Next step” button to continue to import the photos and/or signatures.

## Export data

- A. To export data, first select if you would like to export all records or just a selection.
- B. Now click on the “Export” button and a CSV file will be generated.



*Fig. Example of exporting BadgeMaker project data.*

## Export photos

At Export photos you have the option to export passport photos and/or signature images.

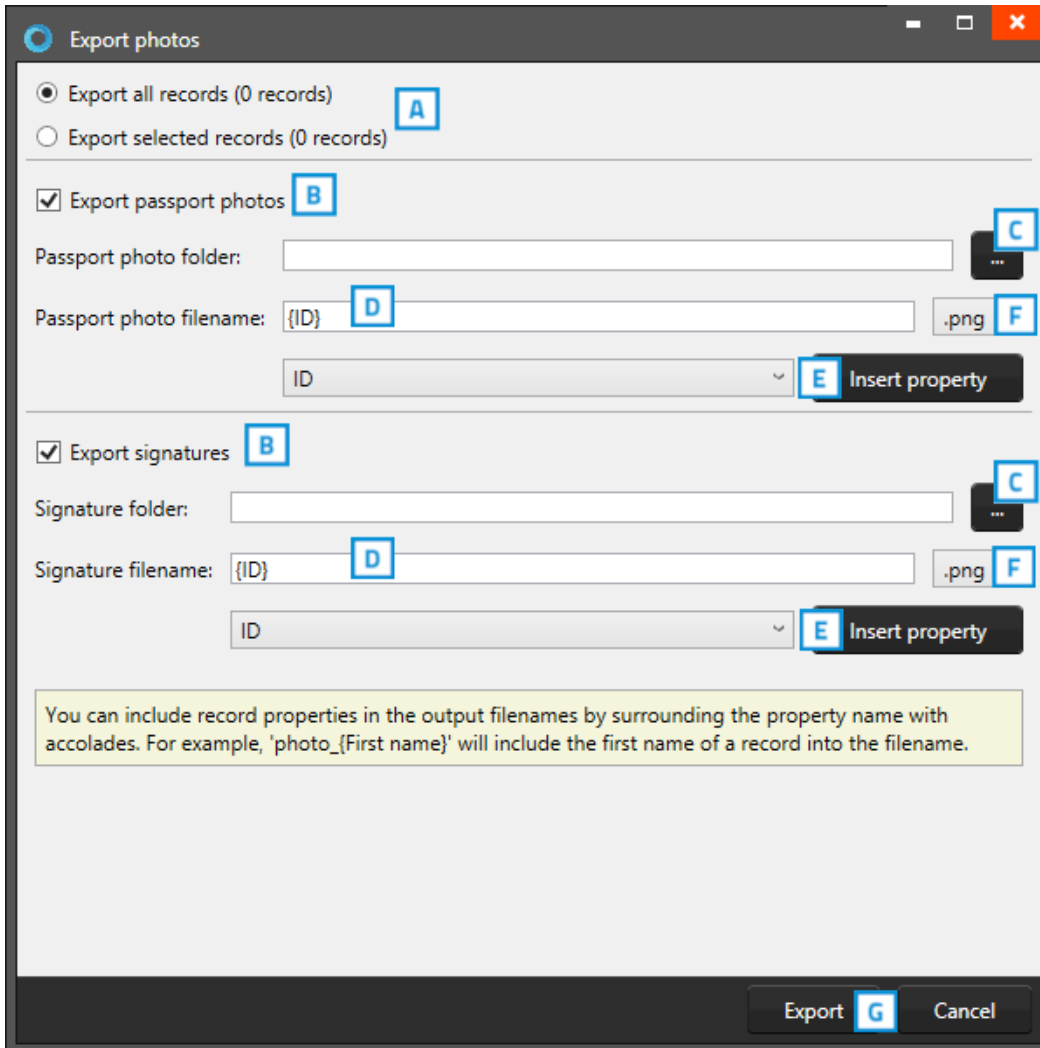
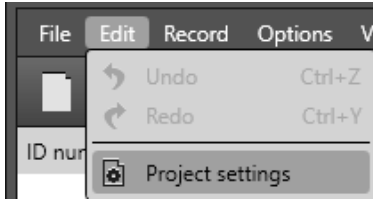

Fig. Example of exporting BadgeMaker project images.

- A. To export data, first select if you would like to export all records or a selection.
- B. Check the boxes to choose to export photos and/or signatures.
- C. Click on this button and select the photos and/or signatures folder you want to export to.
- D. Give the exported images a name.
- E. You can include column properties in the output filenames by selecting a column and clicking on “insert property”. For example: “photo\_{ID number}”.
- F. Select the file type: .jpg, .png or .bmp.
- G. Click on the “Next step” button to continue to export the photos and/or signatures.

## Project settings

To change the Project Settings, go to the Main Menu, click on “Edit” and select “Project Settings” in the sub menu. Go to Project Settings to change the setup, project structure or to add and manage Card Designs in your project. Make sure you click on the “Save” button when making changes.



## Detail View

At the first link you can configure the layout of the detail view. The detail view is the view shown in the middle of the dashboard, giving you detailed information of a record.

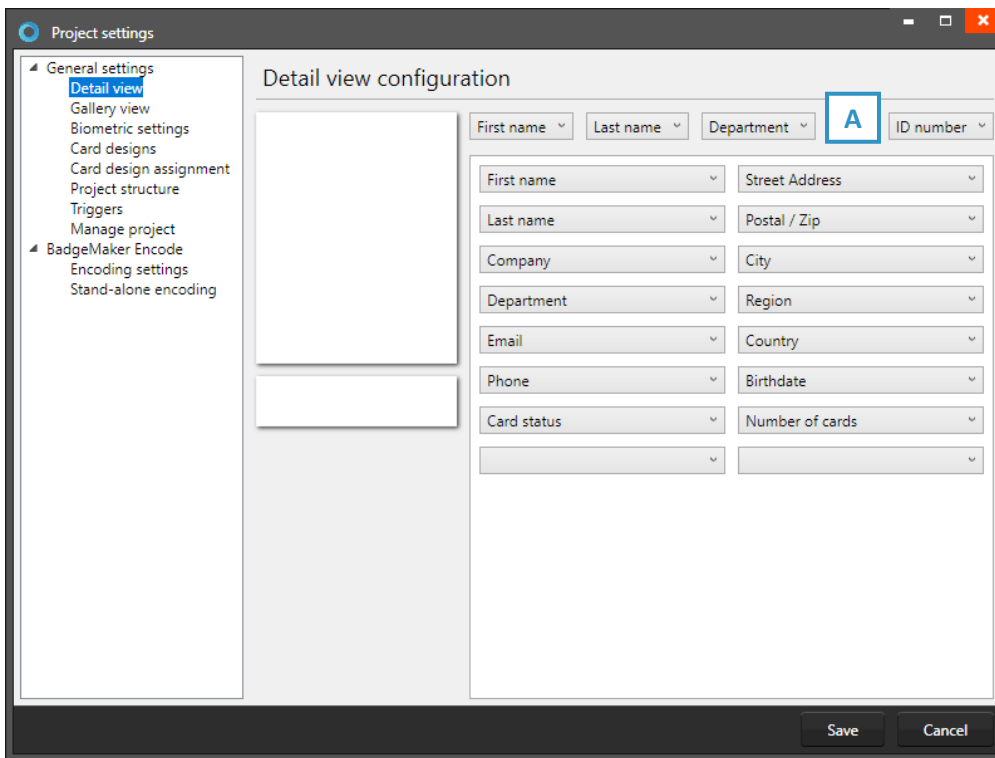
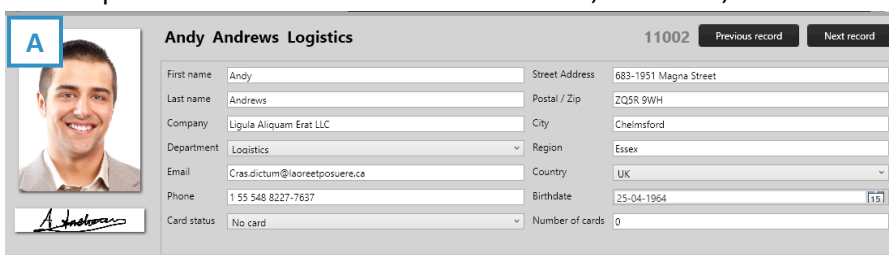

Fig. Example of the Project settings: Detailed view configuration

- A. Use the drop-down menus to select where you want to see certain data fields. At the top are usually the most important fields selected like the first name, last name, and ID number.



Example of the A. Detailed view

## Gallery view

The Gallery view is a photo slide presentation to find the persons' record very easily when people are showing up at the front desk to change or replace a card. In the Gallery setting you can select 2 (two) database fields that are presented with the Photo. You can select First name and Last name or choose for the record ID or any other database field.

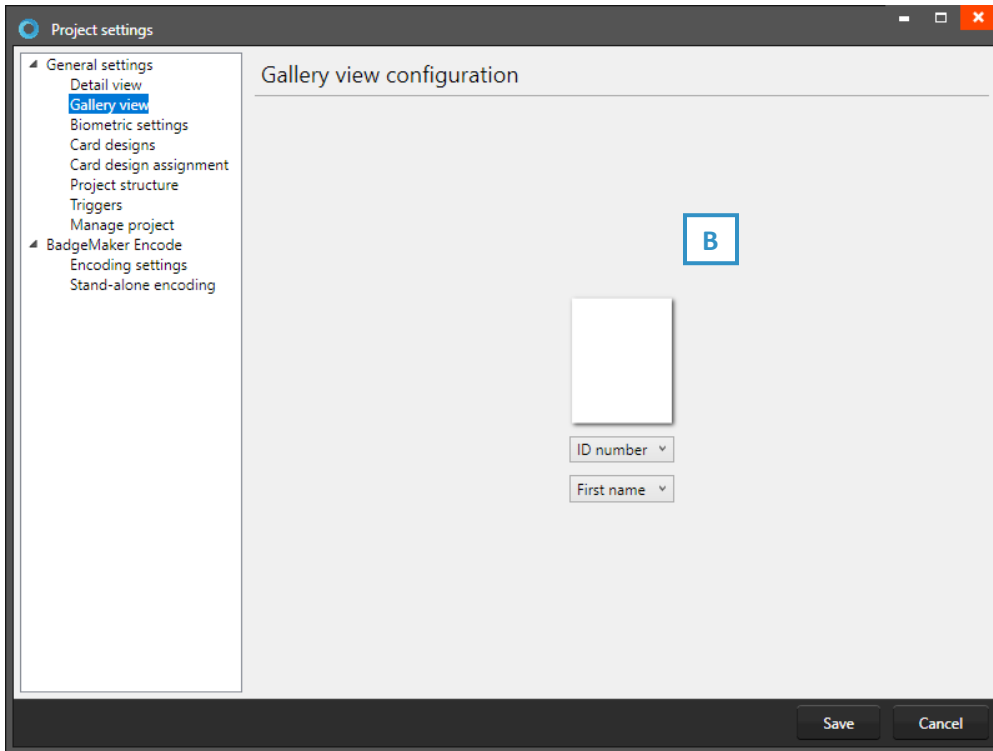

Fig. Example of the Preview Project settings: Gallery view

- B. In the Gallery setting you can select two database fields that are presented with the Photo. You can select First name and Last name or chose for the record ID or any other database field.



Fig. Example of the A. Gallery view

## Biometric settings

The Biometric settings is for managing the Passport Photos and/or Signatures in the project. Add Photo's and Signatures or adjust the settings for the photos or signatures.

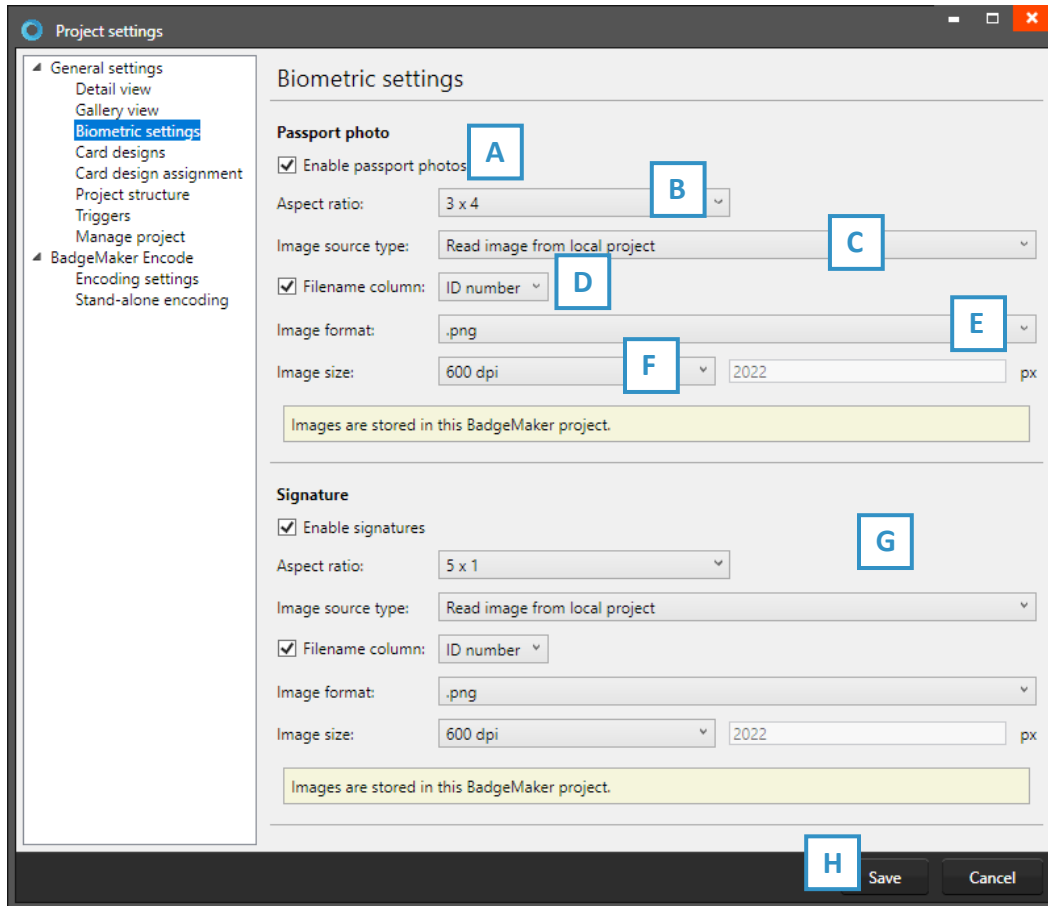
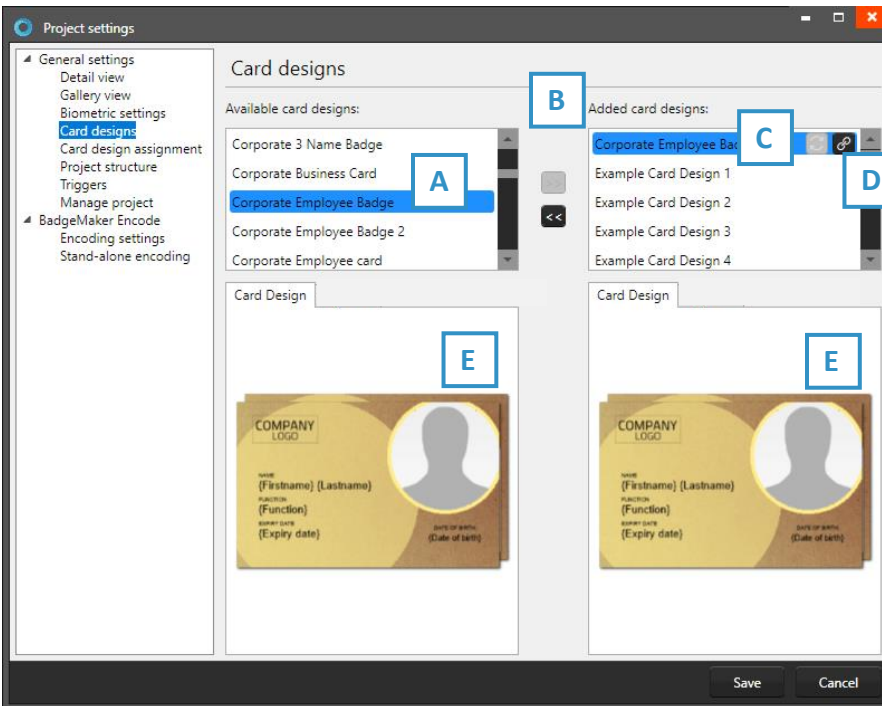

Fig. Example of the Project settings: Biometric settings

- A. The box for passport photos makes photos visible in the project and enables you to add photos.
- B. After checking the box, you can determine the ratio of the photo.
- C. Select how and where photos will be saved within your project.
- D. Check this box if you want to use data columns to represent the filename.
- E. Select the image format. This can be .png (often used for transparent images), .jpg or .bmp.
- F. Select what size the photos need to be saved as within your project.
- G. The box for the signature makes signatures visible in the project and enables you to add signatures. The signature section works the same as the passport photo section above.
- H. Click on the “Save” button to save the changes you made.

## Card Designs

Adding and managing Card designs to your project.



- A. Select one of the available designs.
- B. Click on the “>>” button to add a selected design to your project.
- C. A card design in your project has two icons available, this is the “Update” icon:



An adjusted card design can be updated to the latest version by clicking on the update icon.

Fig. Example of step 4. Add Card designs to your project.

- D. A card design in your project has two icons available, this is the “Bindings” icon:

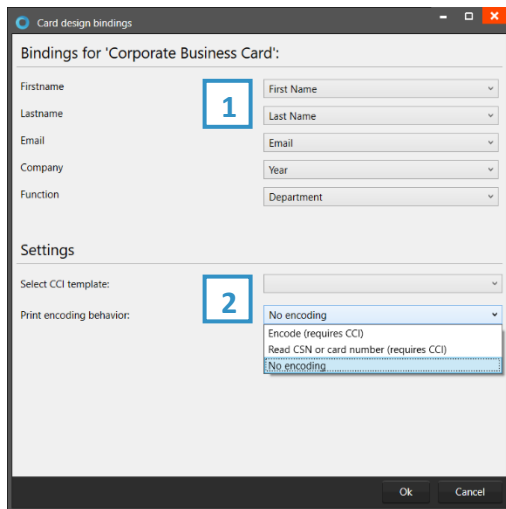

Click on the bindings icon to edit the bindings for the dynamic data of the card design. The bindings window pops up automatically after adding a design to your project.

*The data binding tool is a powerful option in BadgeMaker Identity. When you add a new layout or update a layout you will be prompted to create the data bindings. Dynamic fields used and created in your layout may differ from the naming or spelling of a name that exists in your Project database. Therefore, you will be allowed to create the data bindings.*

### 1. Card Design bindings

The dynamic fields that are created in the card design are presented to the left and you can bind these dynamic fields to the database fields of your project.

### 2. Settings

**CCI template:** Bind a CCI encode template to your card design to encode the card during production. For more information go to “[BadgeMaker Encode](#)”. If you do not need to encode with this card design, you can leave this option blank.

- E. The Card Designs tab offers a preview of the card design. If the card design has a front and a back, you can toggle between the two by clicking on the design in the preview.



## Card designs assignment

It is possible to assign the card designs using a specific project column. Click on the drop-down menu to select the column.

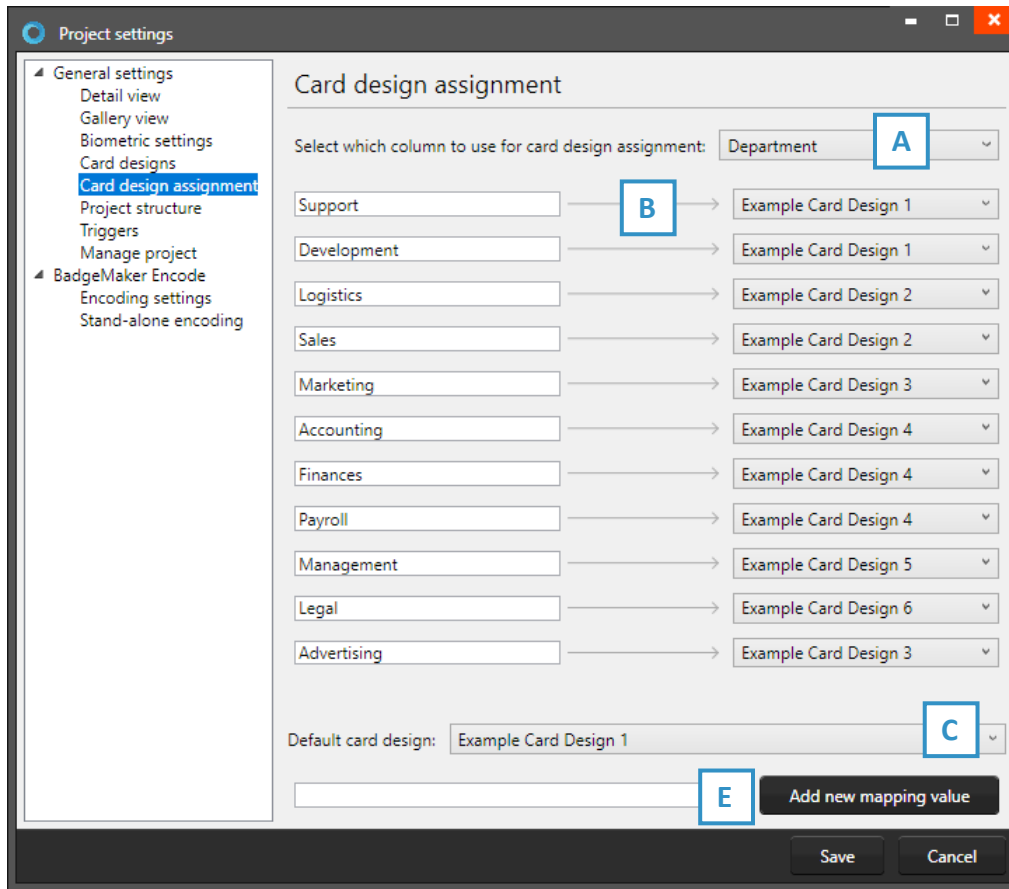

Fig. Example of the Project settings: Card design assignment

- A. Select from the drop-down menu which project column to use for card design assignment.
- B. The data of the selected column can now be linked to a card design that has been added to the project.
- C. Select a default card design for when the cardholder's information is not associated with a card design.
- D. It is possible to add more values to the column to link with. Type the new value in the field and click on the “Add new mapping value”.

## Project structure

The Project structure settings is for managing your structure. You can create, edit, or delete columns.

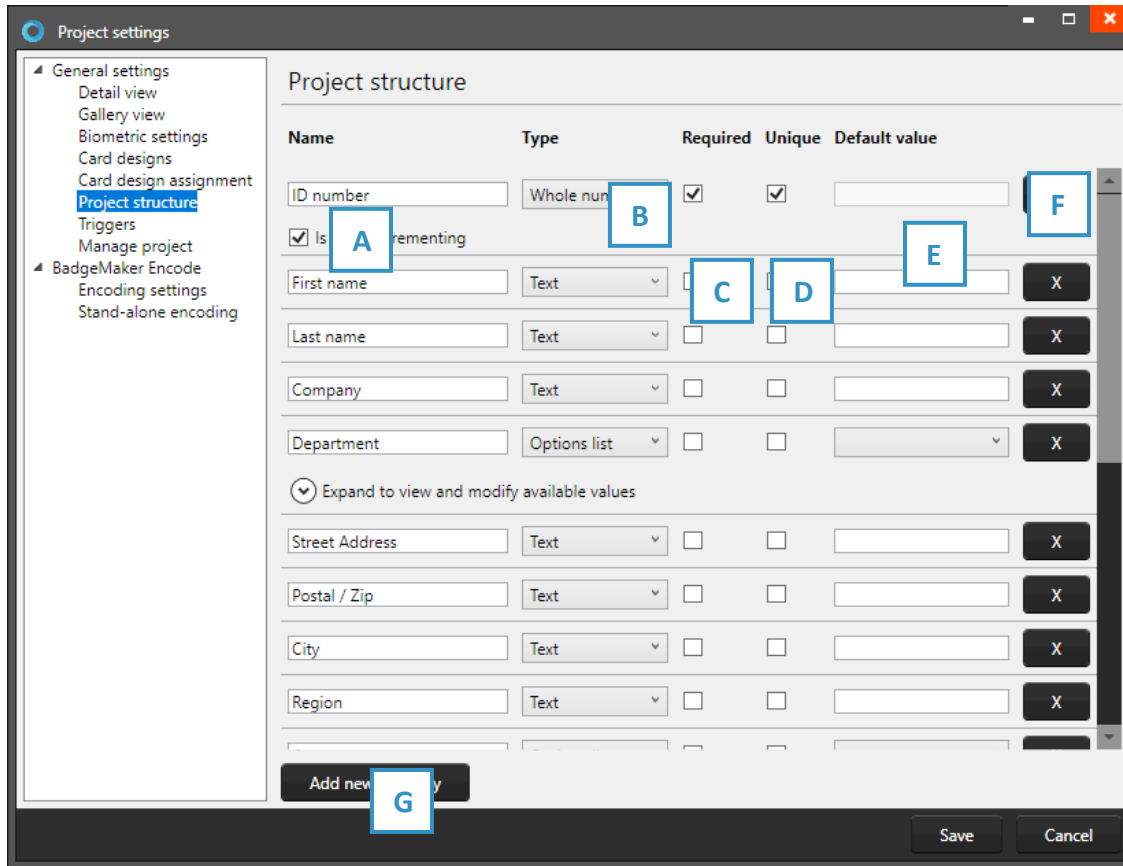

Fig. Example of the Project settings: Structure Text

- A. Adjust the columns name.
- B. Adjust the data type. Select if the data is number or text for example. The following types of database fields are supported:
  - *Number: When selecting this type, you can select 'auto-increment'. When a new record is created the number will be the highest number in the project increased by 1*
  - *Decimal.*
  - *List: When this type is selected you can add and delete the list values from the list that is presented for this database field when a value must be entered.*
  - *Date.*
  - *Email address.*
  - *Phone number.*
- C. Select if the field needs to be required. For each field you can select 'required' when this database field must be entered for a (new/edit) record.
- D. Select if the field needs to be Unique. For each field you can select 'unique' when the entered value must be checked for its uniqueness in the Project.
- E. With the default input field, you can add a standard value to your data field, existing empty fields and new records will automatically display the default value you add to this data field.
- F. Click on the "X" to delete a column/data field.
- G. Click on the "Add new property" button and add and describe the data column name you want to use in your project.

## Triggers

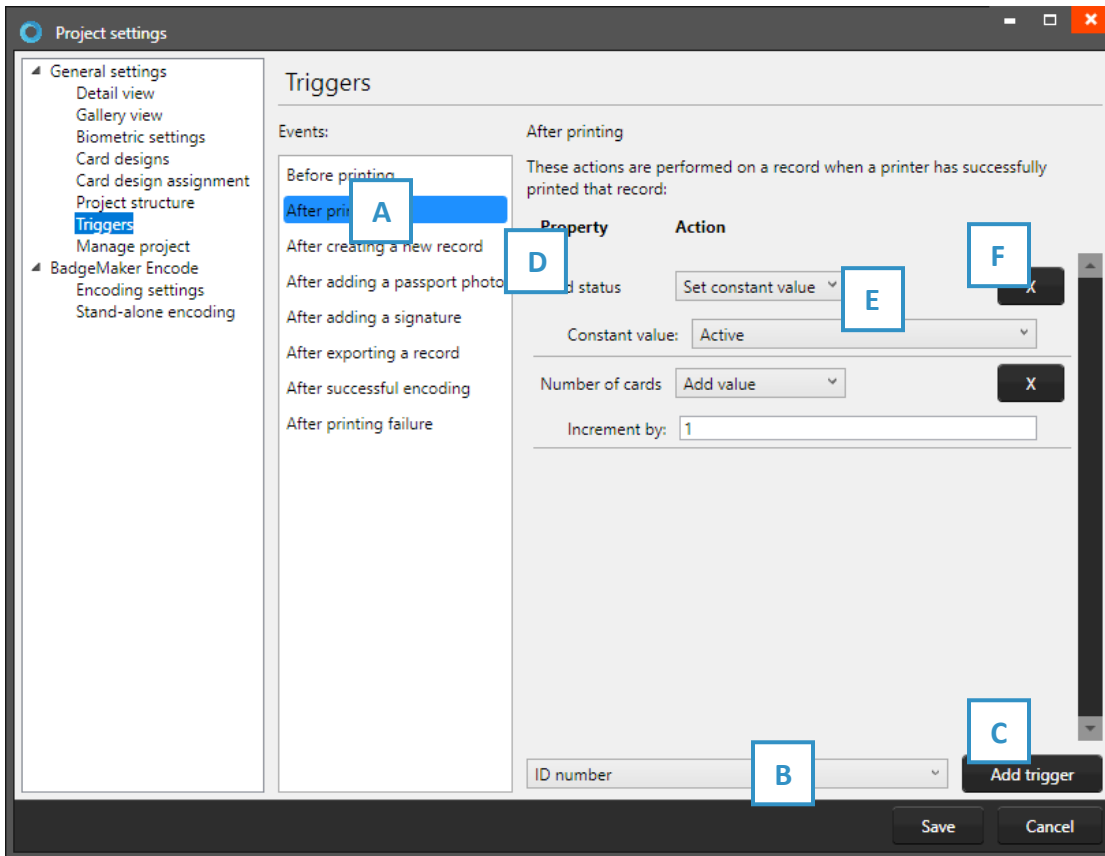
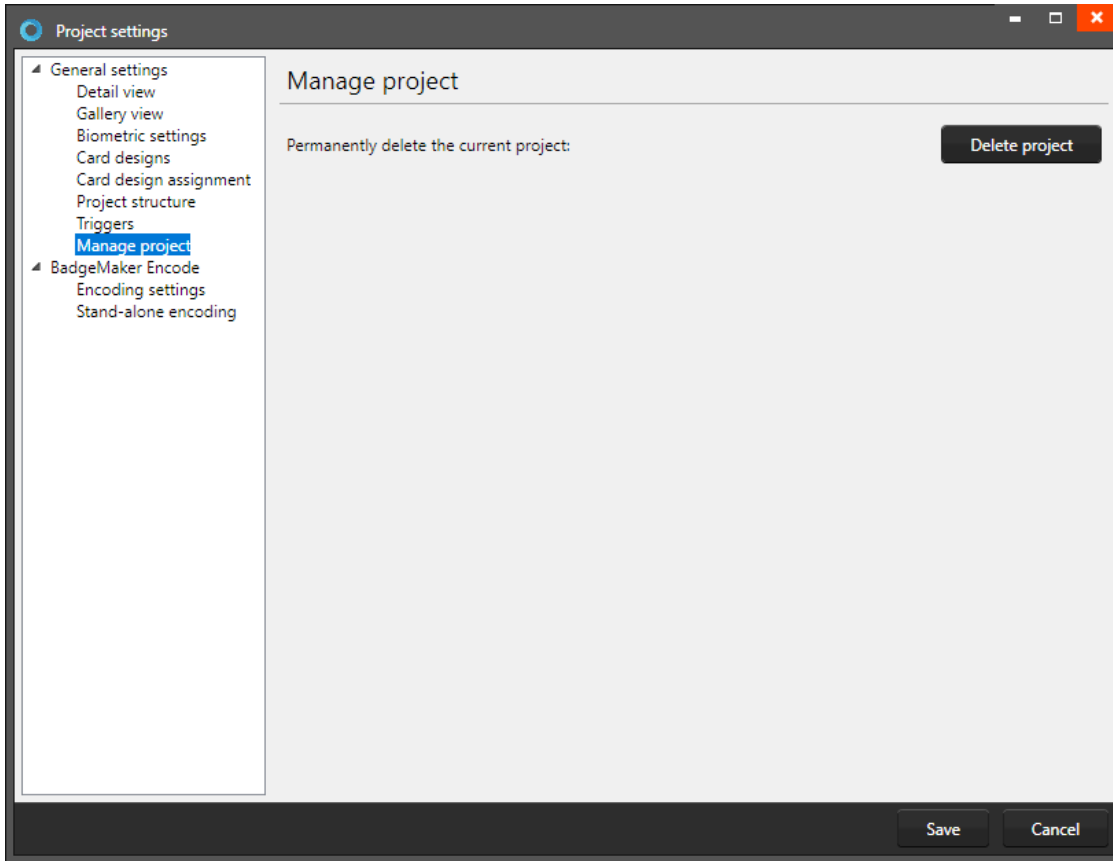

Fig. Example of step 4. New project: Triggers

- A. Select one of the events from this list and add specific triggers. BadgeMaker Identity will automatically wait for the event to occur before performing the action that is linked to the trigger.
- B. All data columns of the new project are listed. Select one of the columns to link a trigger action to it.
- C. Click on the “Add trigger” button to add the trigger to the data column and specify the trigger with events and actions.
- D. The property shows you the selected data column.
- E. Select the action you want to connect to the data column from the drop-down menu and define the action.
- F. Click on the “X” button to delete a trigger.

Define the action that is performed once the event has been met. Some actions are only available for specific columns (for example, incrementing number values can only be done on Number type columns). All changes need to be saved before they become active. Understand that triggers might cause your original data to change, so make sure no vital data is lost when working with triggers.

## Manage Project



*Fig. Example of the Project settings: Project management*

This link is for managing your project. You can completely delete the current project you are working on.

## Record

Records are single data rows that contain all the information of one person. There is a button for adding and deleting a record.

### Add a new record

If you add a record a new pop-up window will appear to enter the new record. The entry form allows the user to enter the data, link a card design and capture a photo and/or signature.

#### 1. Information

- A. Enter the needed information for each field and click on the
- B. Select a card design from the drop-down menu to link the new record to the card design.

Click the “Next Step” button to add a photo and/or signature.

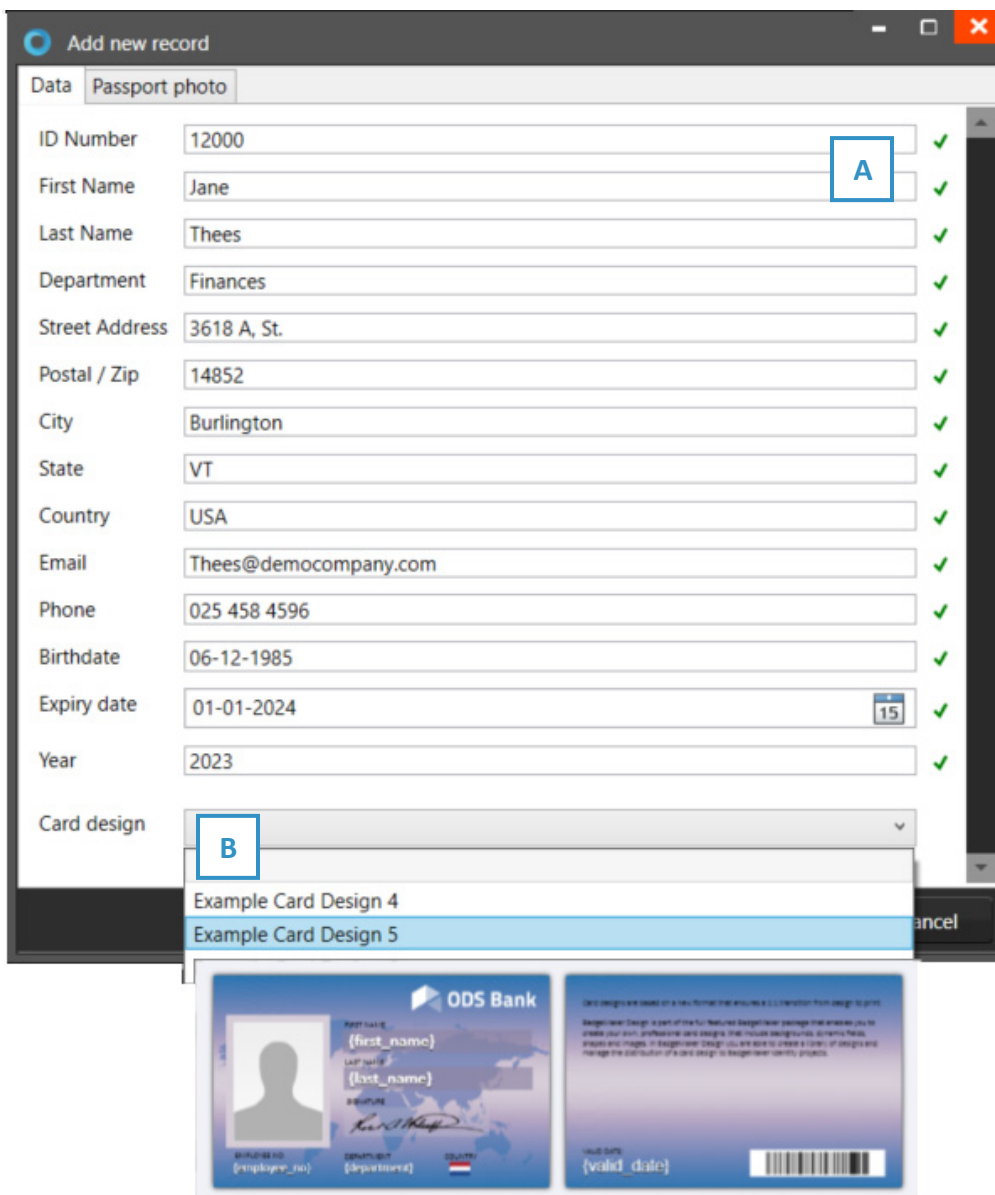

Fig. Example of the information tab when adding a new record.

**2. Photo**

A. Select the source of camera you want to use from the drop-down menu. You can choose to use your webcam or a TWAIN camera that is installed and connected to your computer.

B. Click on the “Start automatic capture” button. The application will detect your face automatically and take three pictures. You can select one of the three pictures to add to the new record.

C. The Photo functionality will show you the camera view.

D. Click on the “Capture photo” button. The Photo functionality will show you the camera view. You are also able to upload an image from your computer. Click on the “Open file...” button to select an image from a file.

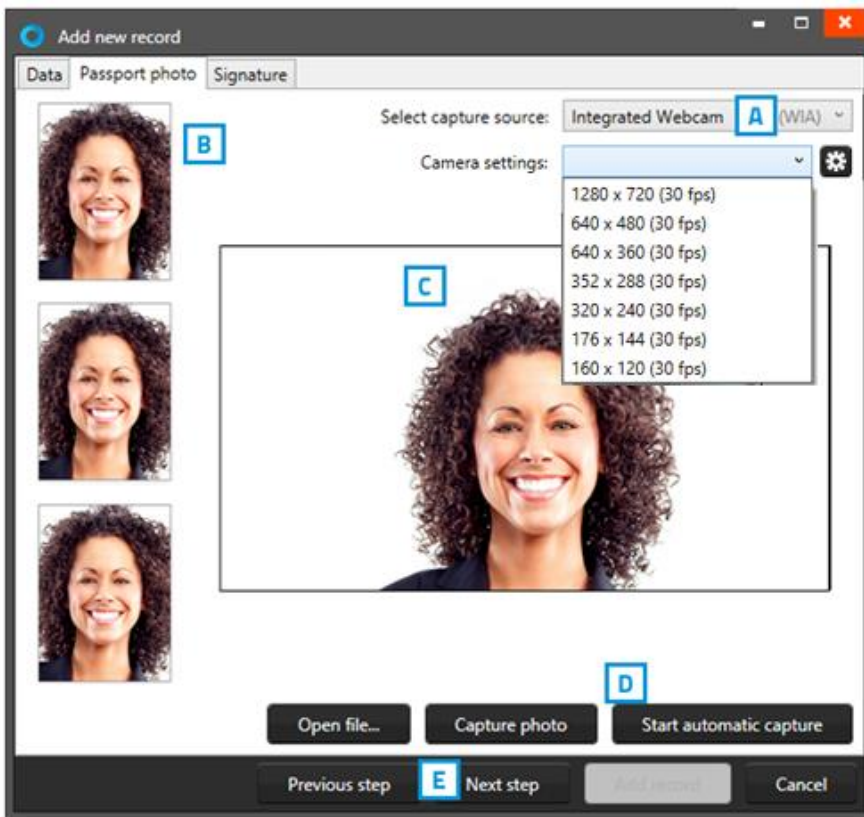

Fig. Example of the photo tab when adding a new record.

### 3. Signature

A. Use a signature pad to write a signature into this field.

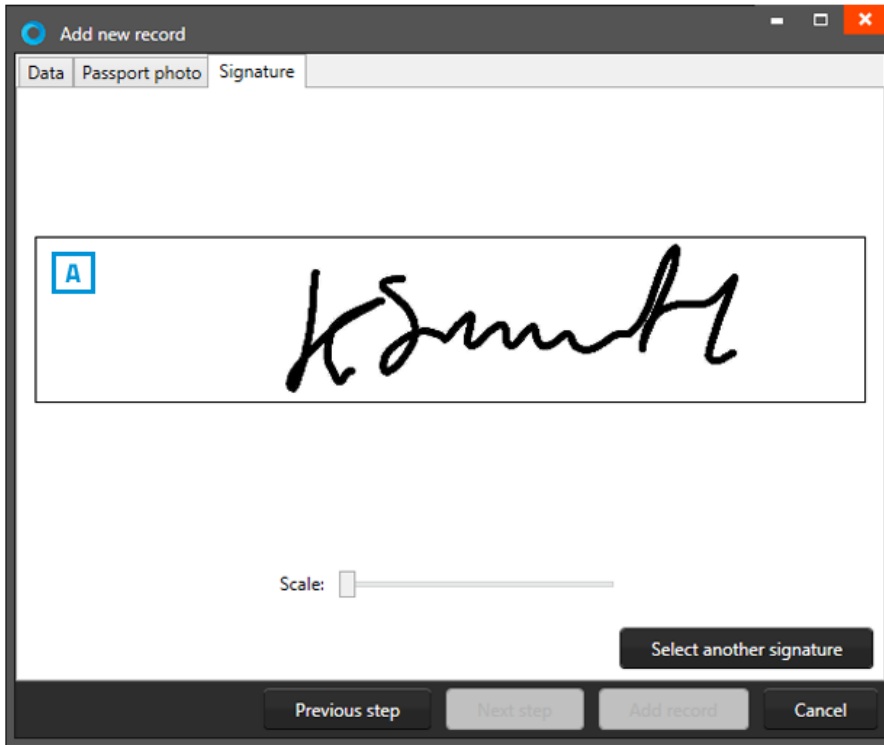

Fig. Example of the signature tab when adding a new record.

## Layout connection to record

The lay-out connection of a data record to a lay-out is needed when a card is going to be printed.

When a data record is selected click on the **A. “Link”** button of one of the card designs in the Card Designs Gallery view to connect the design to the record. To change the connection to a different lay-out the user can click on the **B. “Unlink”** button and link another design.

When you make changes to your design in BadgeMaker Design you can update your card design in your BadgeMaker Identity project by clicking the **C. “Update”** button.

It is possible to select more data records at the same time and connect the selected records to a lay-out. Use CTRL+A, + CTRL or +SHIFT

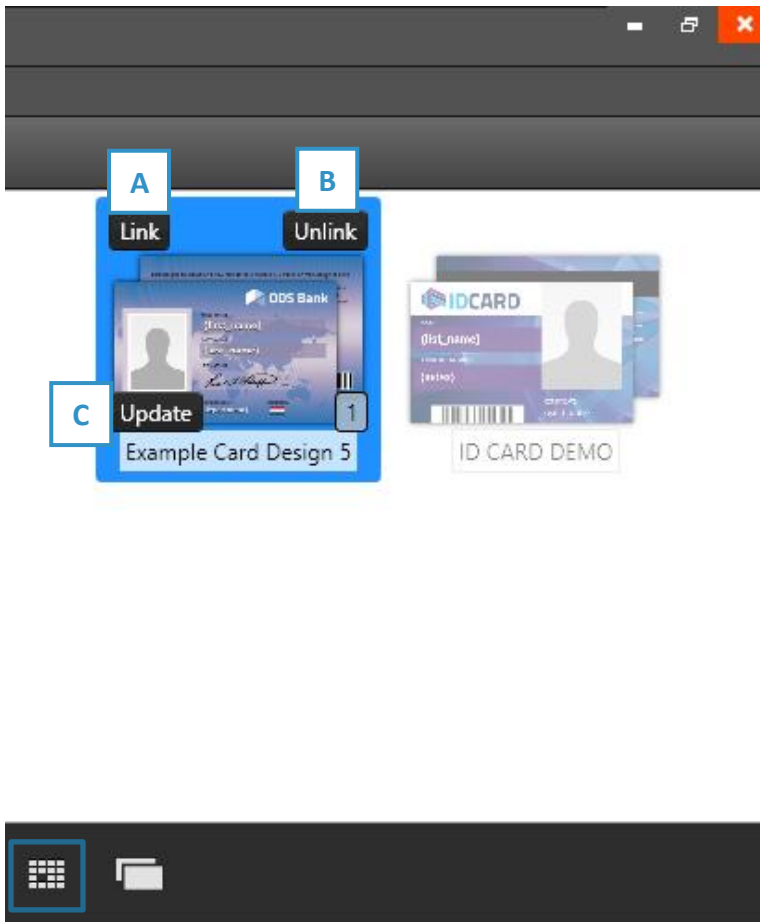





# USER GUIDE ADD-ONS

## BADGEMAKER ENCODE

2024 October

User Guide V2.11.12

BadgeMaker Encode V2.11.12

## BADGEMAKER ENCODE

The BadgeMaker Encode Add-on allows you to encode data from your BadgeMaker Identity project onto a smart card. With BadgeMaker Encode, ScreenCheck introduces a new file format that is used to contain all information related to the encoding of the card, which can easily and securely be shared with other parties who collaborate on the same project.

### Contactless encoding

BadgeMaker Encode currently supports the encoding of MIFARE Classic, Plus and DESfire cards. Encoding is done using card printers that are fitted with a “reader” such as the HID Omnikey or the Springcard Crazy Writer. For a detailed overview of supported devices and standards, please refer to the supported hardware chapter on page 7 in this manual.

### CCI Editor

The CCI Editor is a tool that is made available to all users of the BadgeMaker software package. This tool allows you to create an encoding template for MIFARE Classic, Plus, DESfire, IClass, UHF Gen2 and proximity cards using all the major features for each of the standards.



#### 2.1 Creating a MIFARE Classic Template using the CCI Editor

Launch the CCI Editor, which will open to a blank window. Choose “File” → “New” → “Mifare Classic (1k)” or “Mifare Classic (4k)” depending on your project requirements.

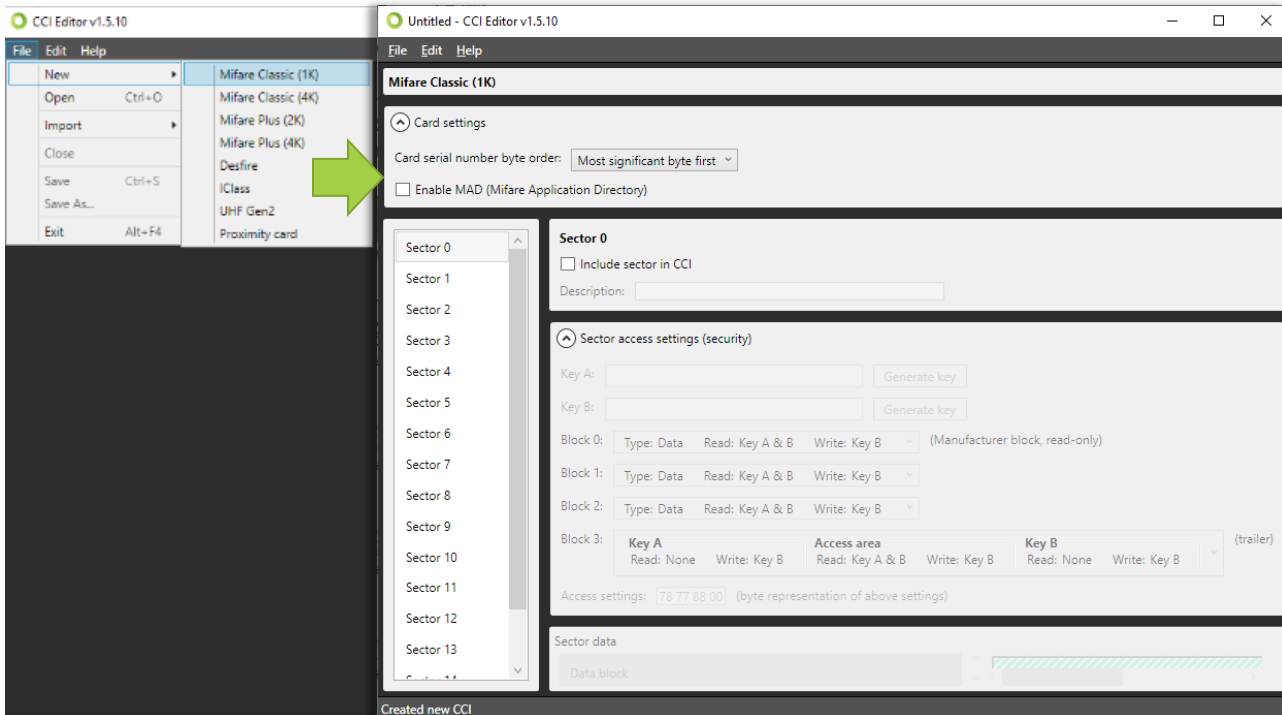

Card Settings is displayed on the top of the screen (A). You can define whether the card should use MAD Sectors or not. Enabling this setting will have an impact on specific sectors and their contents. It will also automatically generate Key A for sector 0 (and sector 16 for 4K cards).

On the left of the screen (F), a list of sectors is displayed, 16 for 1K cards, 40 for 4K cards. Depending on the settings, each of the sectors can contain information that will be encoded onto the card through BadgeMaker Identity.

The center of the screen (B, C, D and E) allows you to configure the information for the currently selected sector. You can define keys, determine read and write settings for each of the four data blocks and create data segments to fill the available space. The CCI Editor visualizes any data that will be encoded onto the Smart Card to give the user a better view of the amount of used and available space in each sector.

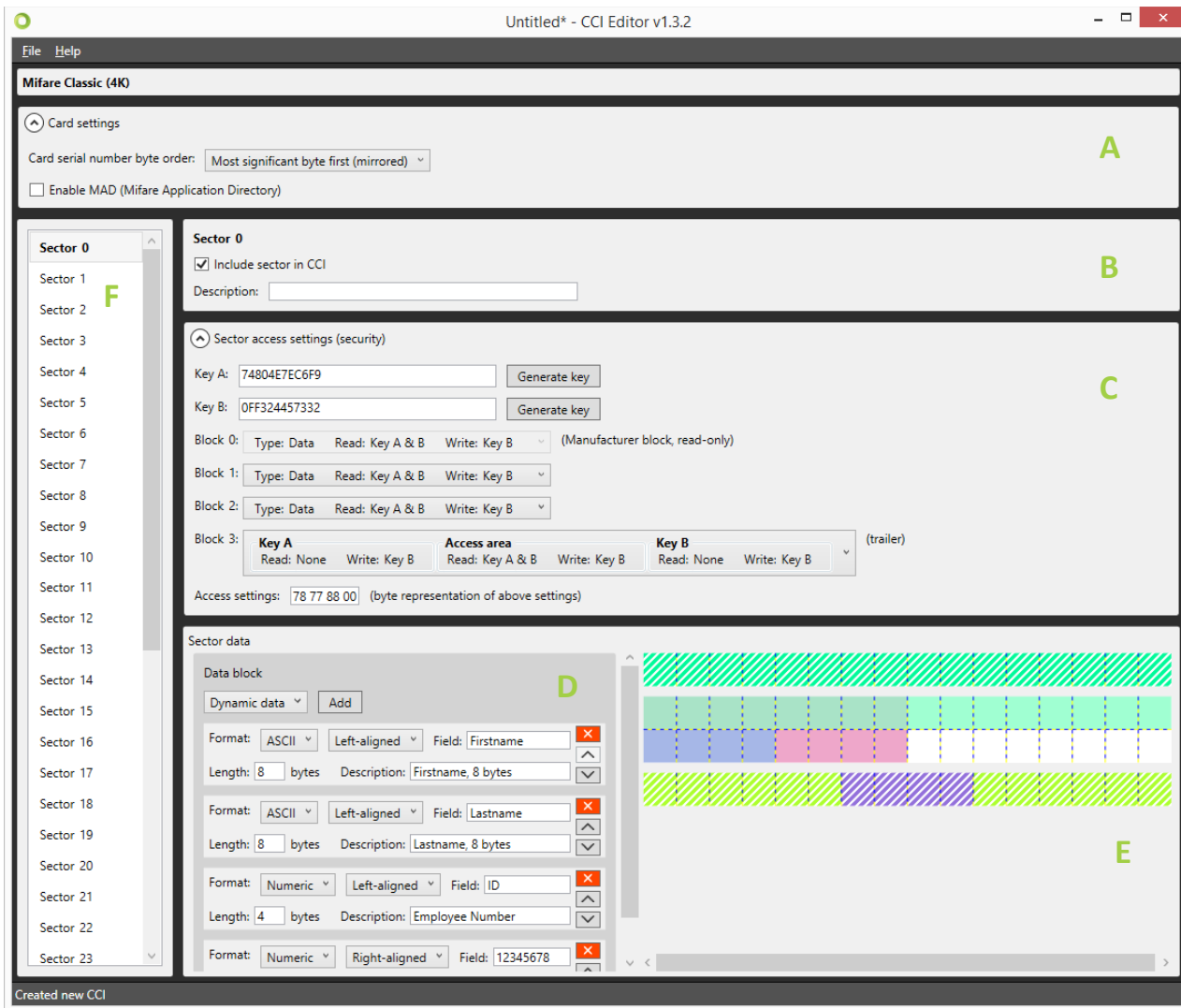

Certain blocks (such as Block 0 on Sector 0, and the Trailer Block on all sectors) are reserved for manufacturer information and storing keys. These are not available to the user and are displayed as hatched.

Each square represents one byte of information. When adding sector data, the length of the data is visualized on the right. Each item in the list is given a slightly different color to make it easier to understand how the data is transferred to the card.

## 2.2 Creating a MIFARE DESfire template using the CCI Editor

DESfire cards take an entirely different approach to encoding compared to MIFARE Classic or Plus cards. With DESfire, you can define Applications and Files that contain information, each with specific access settings. Like MIFARE Classic, launch the CCI Editor, which will open to a blank window. Choose “File” → “New” → “DESFire”.

The Card settings panel will allow you to define general rules for your encoding template. A DESFire card features a Card master key that can be used to re-encode or erase the card at any time. All keys for DESFire cards can be encoded using 3DES, 3K3DES or AES encrypted keys. A key can either be generated or entered manually.

The other options for the Card settings dialog are self-explanatory but must be decided with caution as they will impact how flexible the card can be used after being encoded. In addition to the default DESFire features, reset keys are implemented that allow for cards to be repurposed by users even though the Card master key might not be available. Distributing the Card master key might not be desirable because of possible security liabilities. Multiple reset keys can be created to supply to different vendors.

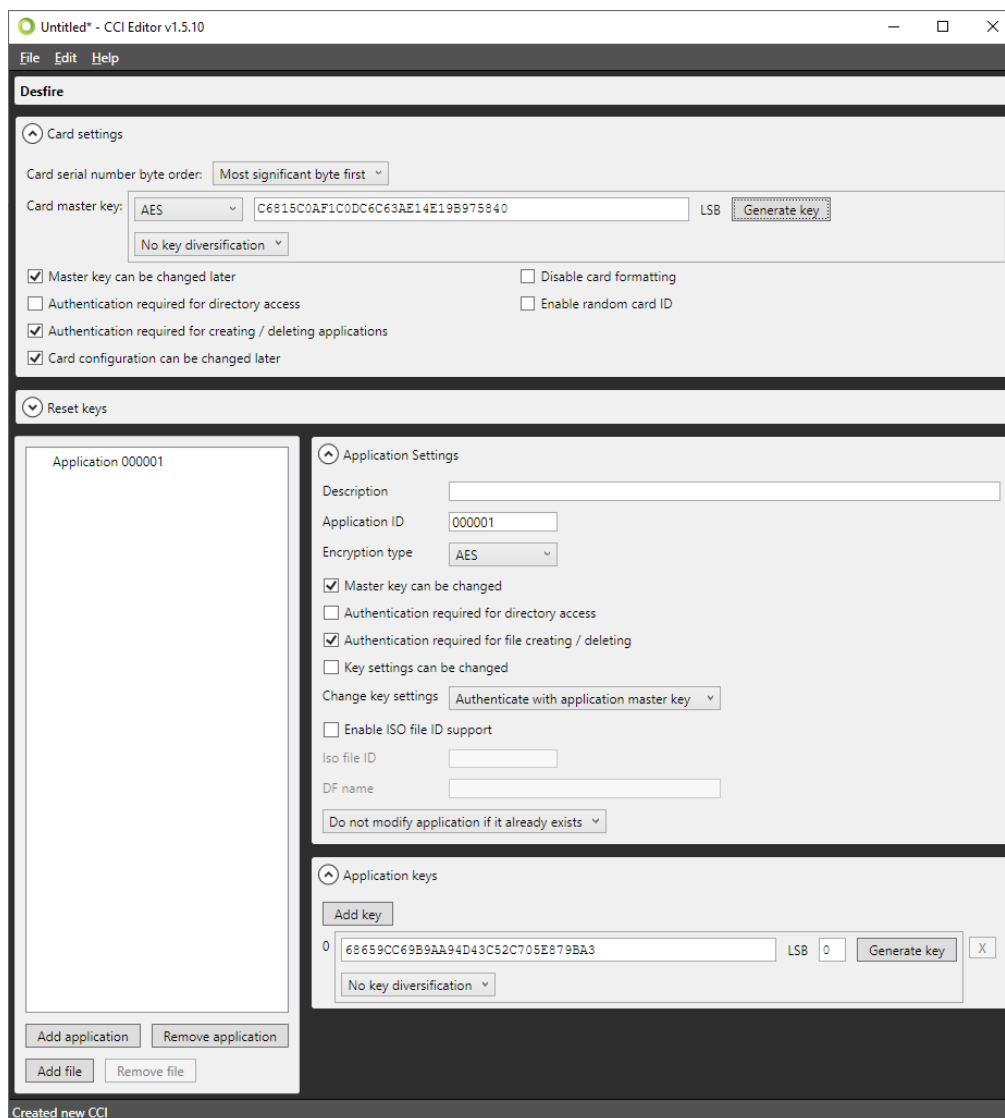

Once Card settings have been defined, an application can be created by choosing “Add application” on the bottom left of the screen. Doing so will automatically create an application titled “000001”. On the right side of the screen, information can be entered to define the application such as a description, an ID (Hexadecimal value)

and the encryption type. For each application, settings are available that define future use of the application such as allowing the Master key to be changed or authentication settings for accessing the data in the application. Each application can have up to 10 keys that can be distributed to vendors for use of the application.

Once finished, choose “Add file” to create a file named “File 0” for the currently selected application. Each file will contain a description and a file number. Communication mode determines the way in which the File is allowed to exchange data. It is highly recommended to use the encrypted setting, as the plain (unencrypted) mode should only be used for data that does not contain sensitive information.

All DESFire File types are supported to accommodate integration with access control or payment systems that support the DESFire standard. For general purposes, select the “Standard data file” from the drop-down list.

Each file has individual settings for Read, Write and Read/Write access, as well as an access rule for changing these settings after encoding the card.

Standard file types require you to set the total file size. Keep in mind that this must be equal to or greater than the total amount of bytes that are used by your file data. In our example, the total amount of data used is 42 bytes, but the file is given 64 bytes instead.

File data is added to the file in a similar fashion to defining MIFARE Classic or Plus templates. Select a data type from the drop-down box and choose “Add” to create a new data block. Define the data format and alignment, as well as the field as this will be the identifier once the CCI file is linked to your BadgeMaker Identity project.

Each DESFire template can contain a maximum of 32 Applications, and each application can contain a maximum of 32 files.

Once completed, the template can be either saved to a human-readable XML format, or a password-encrypted CCI format. Both can be used to encode cards in your BadgeMaker Identity project.

## 2.3 Creating a UHF Gen 2 Template using the CCI Editor

Print and Encode UHF Gen 2 RFID Cards with the Zebra® ZXP Series 7™ Printer. Because this RFID card can be read from afar even through badge holders, handbags, pockets, and backpacks, you can use it to streamline and ease congestion in your identification, access control and transaction processes. The UHF Gen 2 chip houses four memory banks where the data is stored. Some have different bit allocations between the four banks to allow for more user memory or a longer EPC number.

Let us start creating a CCI file to encode a UHF Gen 2 card. Launch the CCI Editor, which will open to a blank window. Choose “File” → “New” → “UHF Gen2

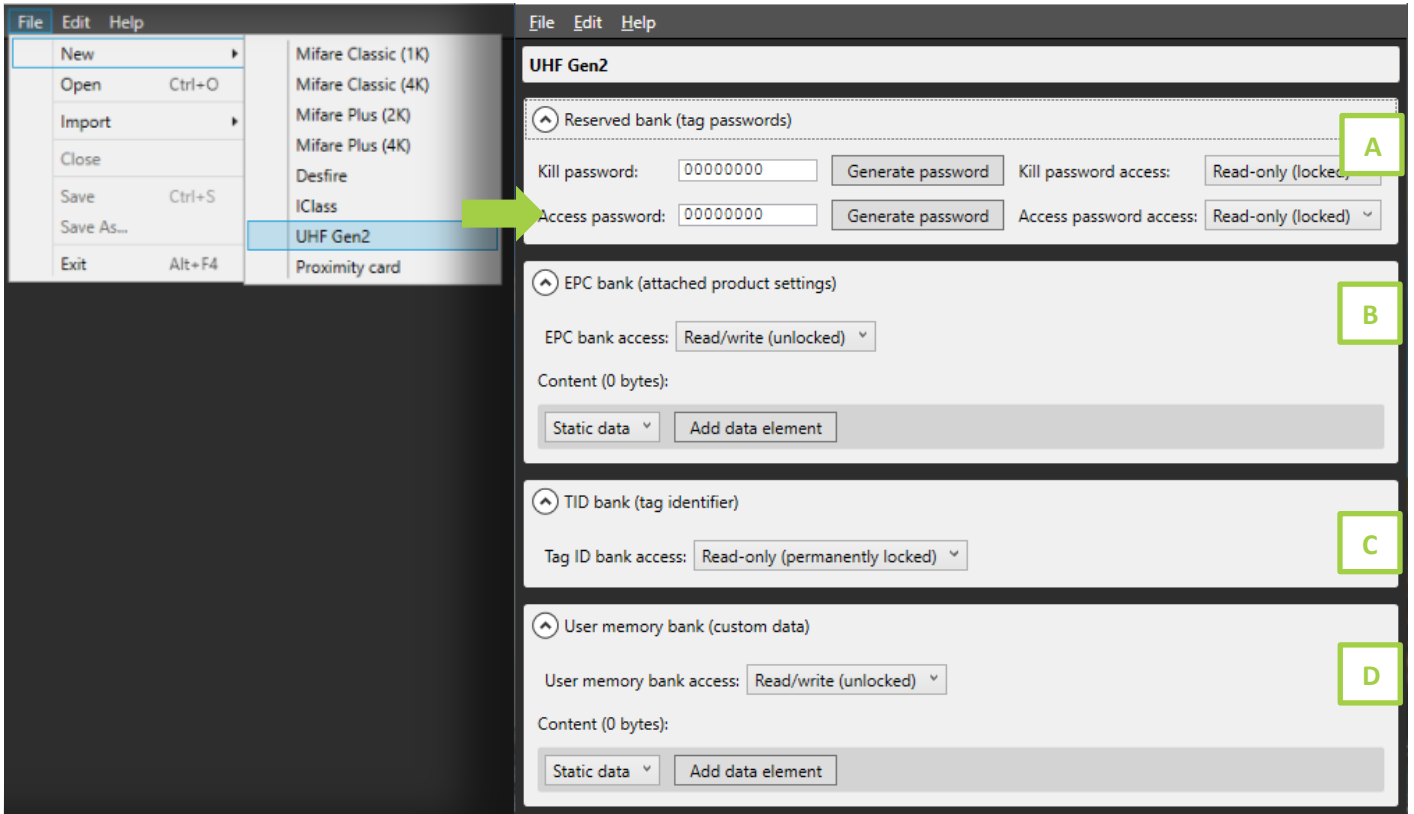

A. **Reserved bank (tag passwords):** The Reserved memory bank allow you to lock or unluck the read and write functions of the RFID chip data. Generate the Kill password and the Access password for the card and determine if the access for these passwords is: Read/write (unlocked), Read/write (permanently unlocked), Read-only (locked), Read-only (permanently locked).

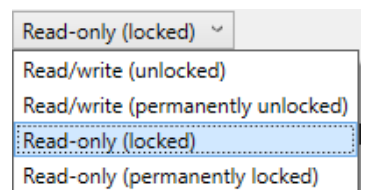

B. **EPC bank (attached product settings):** Determine the EPC bank access by selecting one of the locked or unlocked options in the dropdown menu. Add content like static data, dynamic data or the card serial number to this bank using the dropdown menu and then clicking the “Add data element”. The tag identification code is written to the EPC (Electronic Product Code) memory. It is the encoding that allows to assign this number to the tag. This number is written in the chip’s memory and can then be read by a suitable RFID reader. During encoding, this number can be protected, it cannot be modified or deleted.

- C. **TID bank (Tag identifier):** The manufacturer’s unique identification number is written in the TID (Tag Identifier) memory. This is incremented in the chip at the time of its manufacture.
  
- D. **User memory bank (Custom data):** User memory is optional and provides a place for user-defined data. The user equipped with an RFID reader can write information in the tag or read information already entered. First set the access to the user memory bank using the dropdown and selecting to lock or unlock this bank.  
 Add content like static data, dynamic data or the card serial number to this bank using the dropdown menu and then clicking the “Add data element”. User Memory ranges from 32 bits to over 64k

## CCI Content Data options

The EPC bank and the User memory bank have the option to add content data using data elements. The dropdown menu gives several data element options to add.

The basic data elements:

### Empty Space

This item can be used to indicate a specific part of a sector that will never be used.

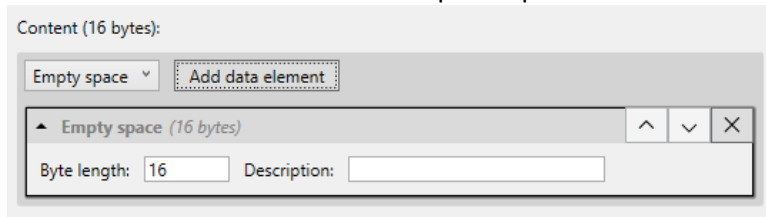
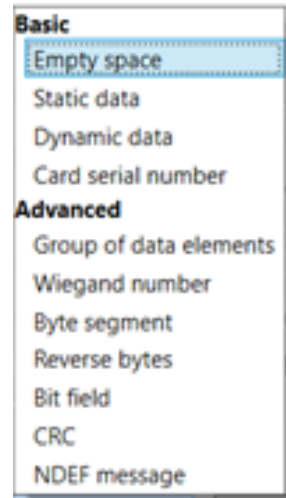

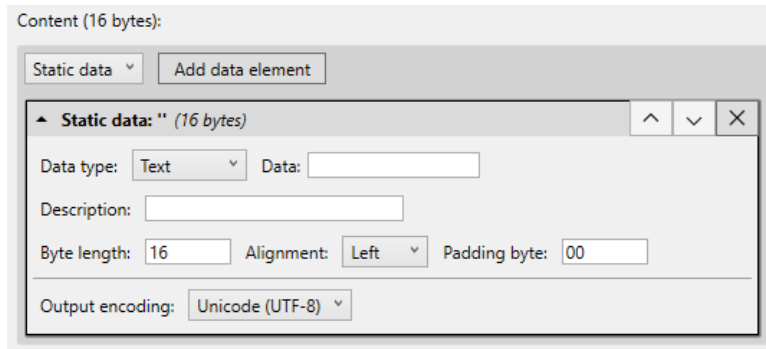

### Static Data

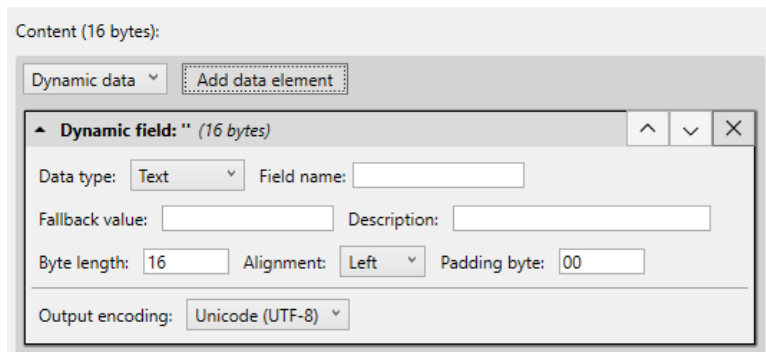

Static data is data that is manually entered in the CCI file and will never change. The format of this piece of information can be of any of the types mentioned in the Dynamic Data section.

### Dynamic Data



This is information that will be added to the card by your project. Like adding card designs, when you add a CCI file to your project, a pop-up will allow you to bind columns in your project to each of these items. You must always ensure that the data in your project corresponds with the settings you have chosen in terms of length and data type.

The following data types are available:

- Text All standard ASCII characters are allowed.
- Whole Number 0 ... 9
- Binary 01
- Date dd-MM-yyyy or yyyy-MM-dd formats (with different separators)

In addition, you can add a description of the sector data to remind you of certain agreements.

### Card serial number

This is a 10, 7 or 4-byte, data section which will automatically contain the card serial number when the card is being encoded. The card serial number is unique for every card.

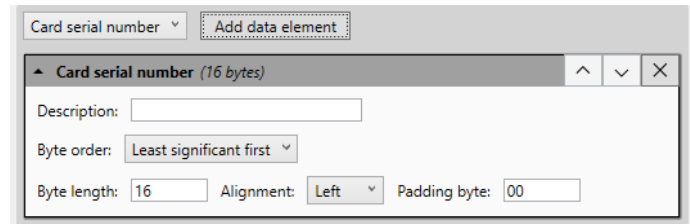

### **The advanced data elements:**

#### Group of data elements

This option lets you join multiple data elements into one group

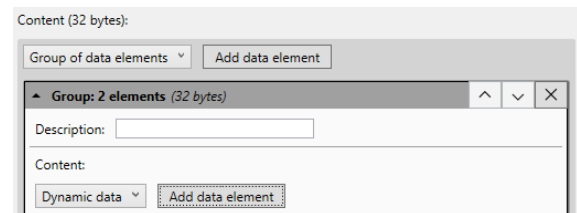

#### Wiegand number

Encode a site code and card number in Wiegand format.

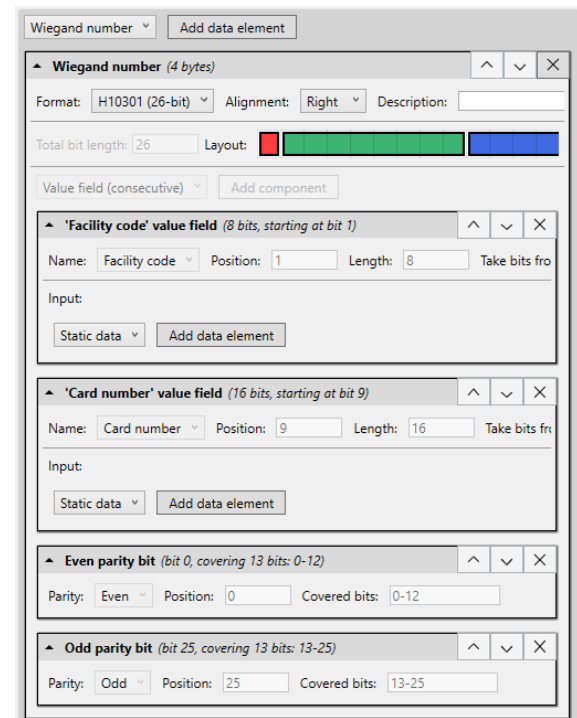



## Byte segment

Takes a specific byte segment from its input.

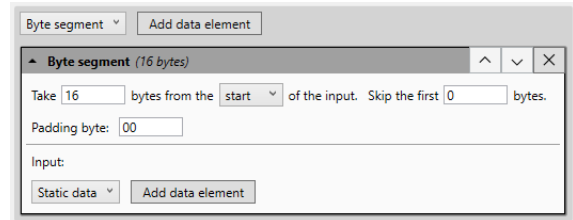

## Reverse bytes

Reverse the bytes from its input: The first byte becomes the last.

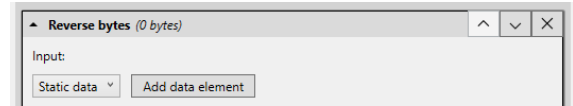

## Bit field

Takes specific bits from its input and packs them into a compact format.

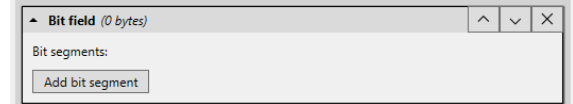

## CRC

Calculates a CRC (Cyclic Redundancy Check) for its input

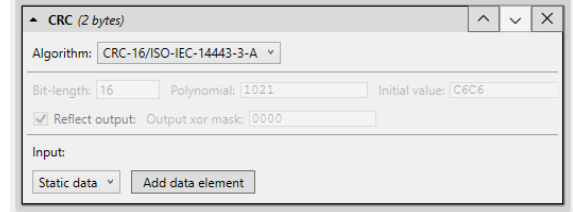

## NDEF message

NDEF is a simple, lightweight data format designed for NFC (Near Field Communication) tags and devices. It defines how data is structured and stored on NFC tags, and how it can be read by NFC-compatible devices. An NDEF message consists of one or more NDEF records, which can contain different types of data such as URLs, plain text, phone numbers, or custom application-specific data. The editor offers the following NDEF record types:

- Empty Record: End of an NDEF message, placeholder.
- Well-Known Type: Standard data formats like text or URL (most common use case).
- Media Type (MIME Type): Rich content like images, audio, or PDFs.
- Absolute URI: Complete URL, not abbreviated.
- External Type: Custom data for proprietary or specialized applications.
- Unknown: Raw, unclassified data, typically used in exploratory or unsupported contexts.
- Chunked Record: When data is too large to fit into one record, and the message needs to be split into multiple parts.

Each of these record types helps tailor the NDEF message for different use cases, from basic URL linking to more complex data encoding and media handling. Depending on your application, one or more of these types may be used for encoding on NFC-enabled cards.

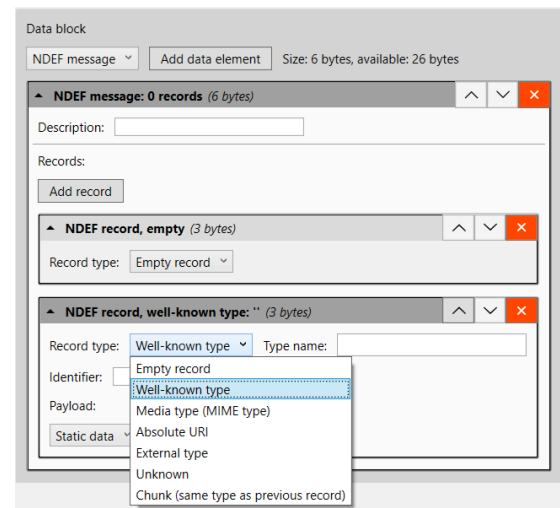

## Encoding with BadgeMaker

Encoding with BadgeMaker Identity has been fully integrated into the printing process. The most important step to enable encoding for your project is to add your CCI file to your project. Go to the Project Settings panel, and select Encoding Settings from the BadgeMaker Encode tab.

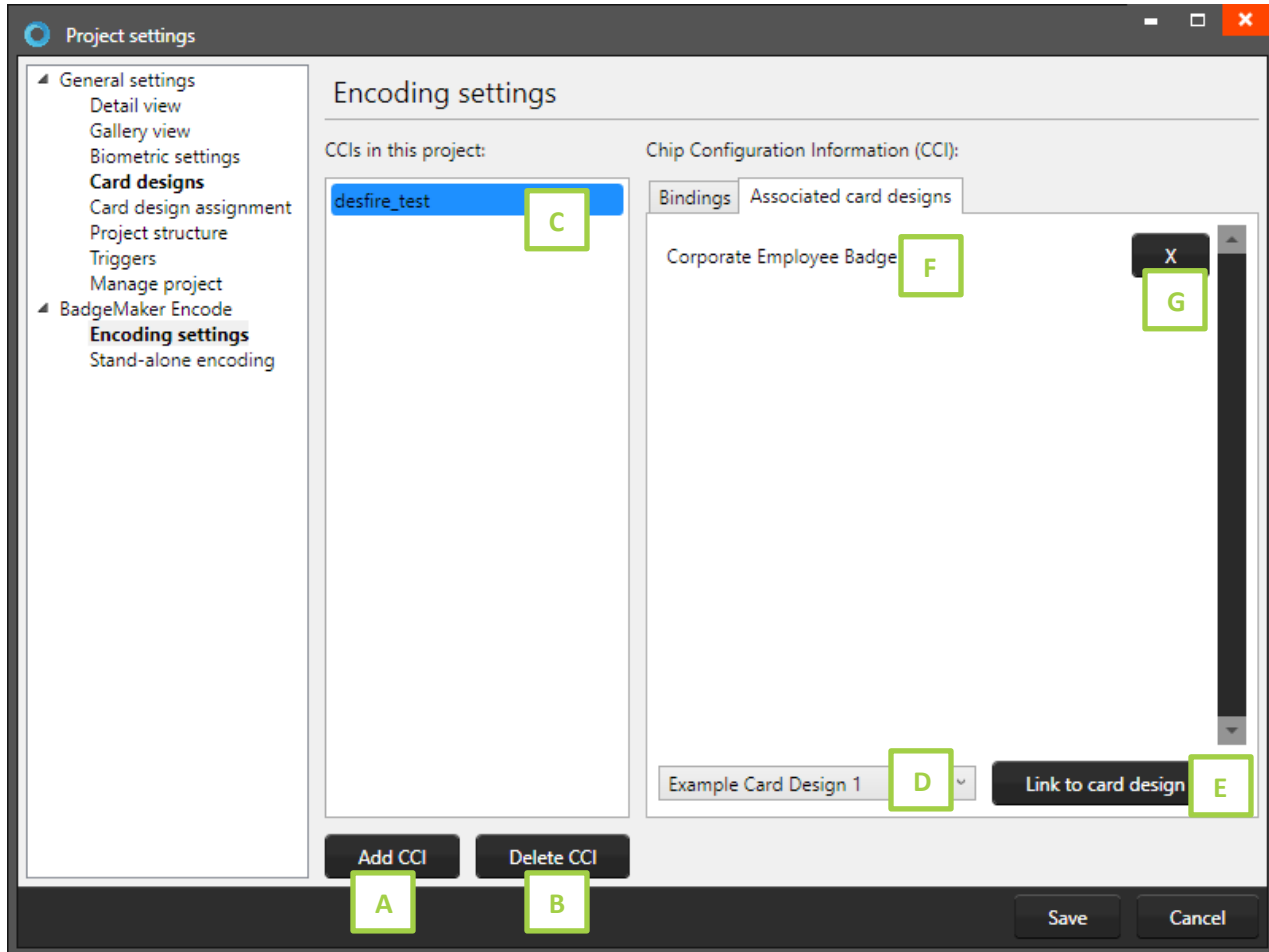

- A. Click on the “Add CCI” button and select the CCI-file you created with the CCI-editor and want to add to your BadgeMaker project to connect to the card designs. When your CCI-file has been secured with a password you first have to fill in the correct password before the file is added to your project.
- B. When you added the wrong CCI-file or want to delete an old file you can select the file from the list and click on the “Delete CCI” button to delete the CCI-file from your project.
- C. Select the CCI-file from the list and click on the “Associated card designs” tab to connect to a card design.
- D. Select the card design from the drop-down list.
- E. Click on the “Link to card design” to link the card design to the CCI-file. Cardholder records with this card design will be encoded with CCI-file linked to the card design.
- F. Overview of all the card designs connected to the CCI-file.
- G. Click on the “X” button to unlink a card design from the CCI-file.

- H. You can bind dynamic data fields from your CCI-file to the data columns of your project just by clicking on the “Bindings” tab and selecting one of the data columns from the drop-down menu.

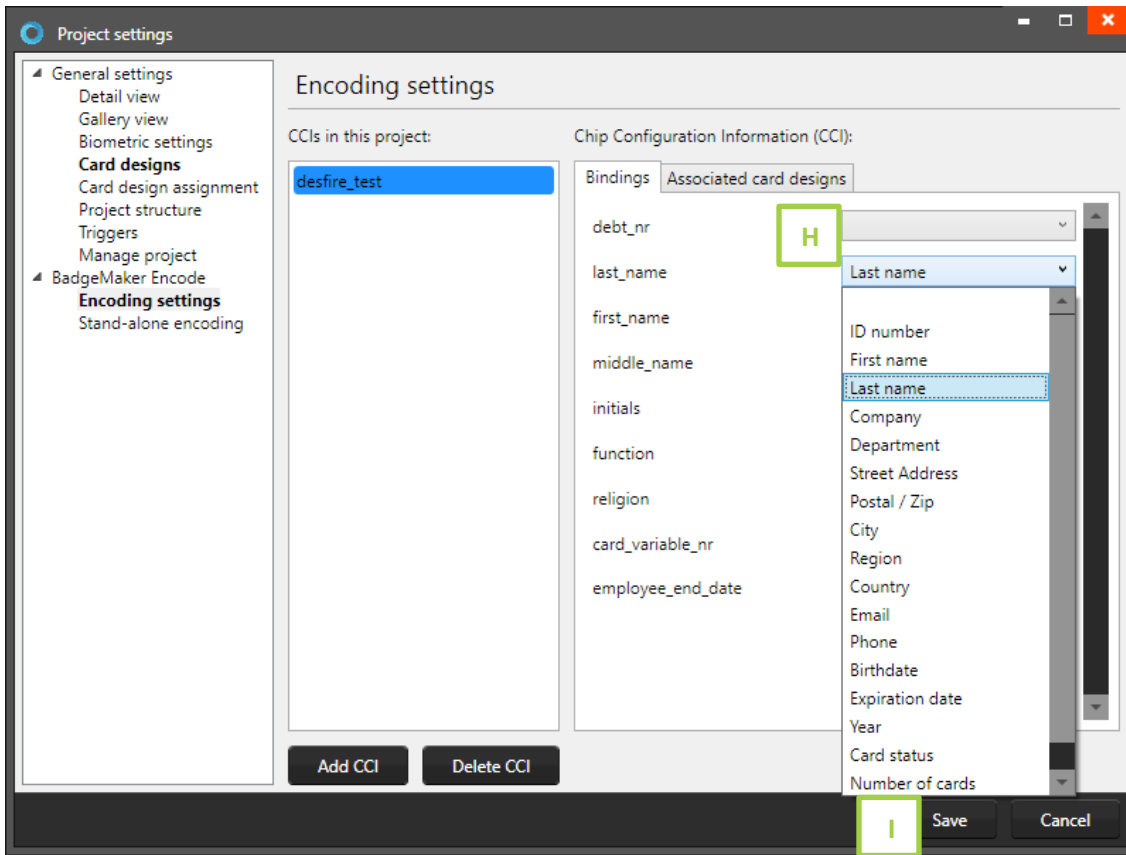

- I. Click on the “Save” button to save the bindings and CCI files connected to your project card designs. You are now ready to encode your cards. Encoding is easy, you select the records connected to the correct card design/CCI-file and click on the print button.

Note that you might need to configure your printer to perform both Encoding and Printing tasks at the same time, otherwise BadgeMaker Identity might list your print action as failed, even though encoding did take place.

### 3.1 Supported standards

BadgeMaker Encode currently supports MIFARE Classic, MIFARE Plus, MIFARE DESFire, IClass, UHF Gen 2, and Proximity card standards.

### 3.2 Supported devices

The manual contains an overview of supported printers and encoding standards, please review page 9 and 10 of the manuals, dedicated to supported hardware for BadgeMaker.

## Stand-alone Encoding with BadgeMaker

Stand-alone encoding allows for rapid lookup and (re)encoding of ID cards from within BadgeMaker. Presenting a new or unencoded card to a card reader allows the operator to select a record and perform and encode the information directly to the card.

Presenting a card to the card reader that has previously encoded will automatically select the corresponding record and gives the operator the option to update the card with the latest information or wipe the card if so desired.

### Stand-alone encoding settings

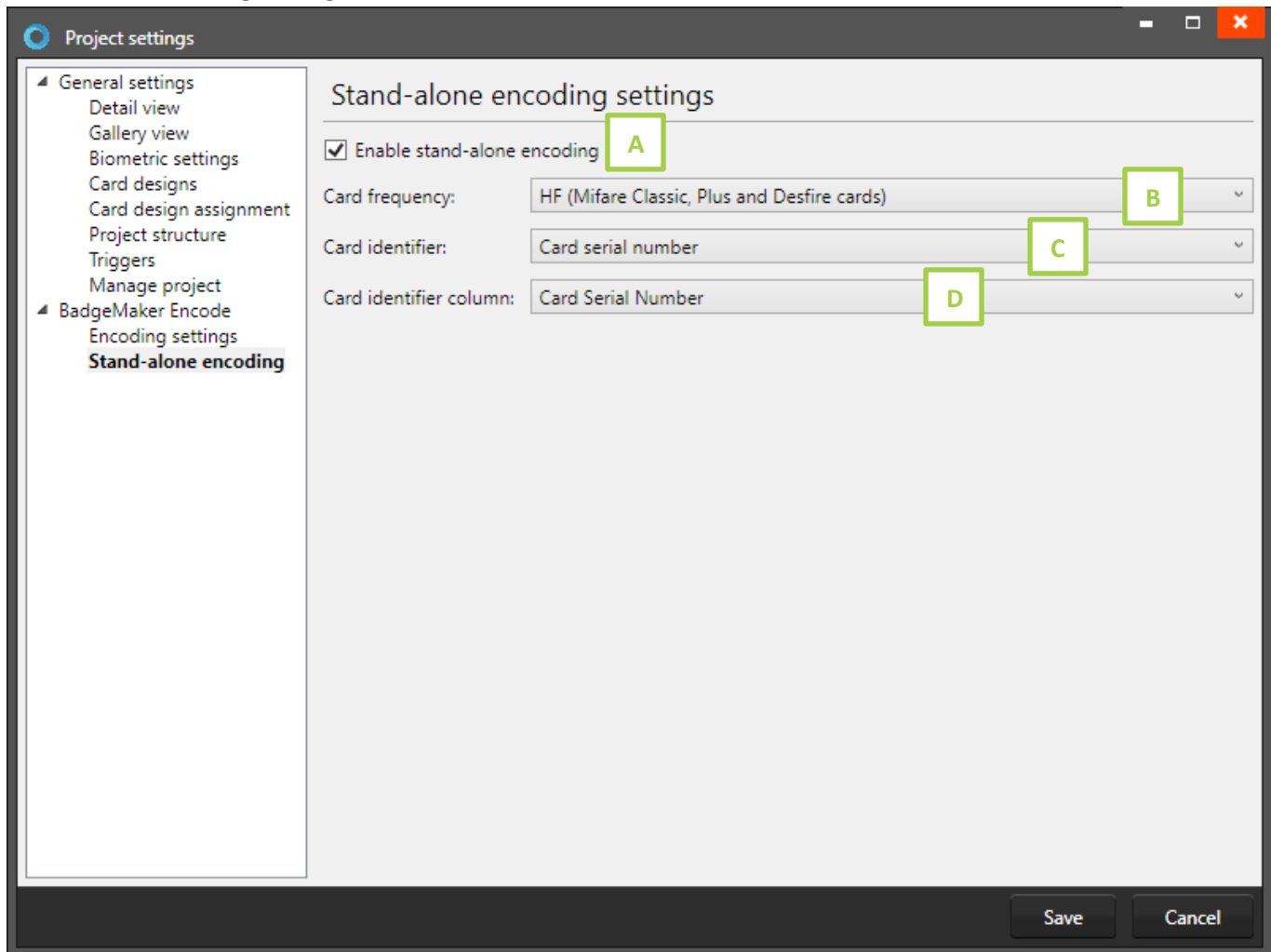

A. Check this box to enable stand-alone encoding.

B. Select the card frequency:

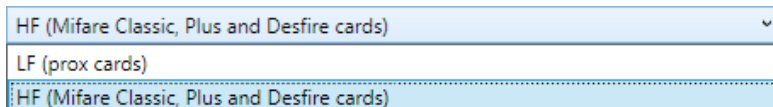

C. Select the card identifier you want to read:

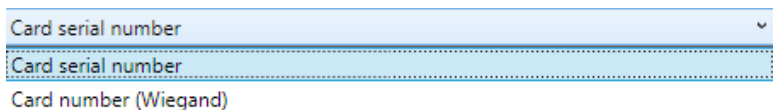

- D. Select the column you would like to represent the card serial number in your project. This column lets you find an existing card and corresponding record and write the card serial number to when encoding a new card for a record.

Card Serial Number

- First name
- Last name
- Company
- Street Address
- Postal / Zip
- City
- Region
- Email
- Phone

Card Serial Number

**Stand-alone encoding**



- A. When stand-alone encoding is enabled in project settings, a new view will be visible in the top corner to use for the stand-alone encoding.

1. Visual representation of a card reader. The image reflects the status of the card reader. The card reader shows an image without a card, when waiting for a card and with a card when a card is in contact with the card reader.
2. Select one of the available card readers to use from the drop-down menu.
3. Shows the status of the card reader.
4. This field shows the card serial number of the scanned card offered to the card reader.
5. Click on the “Find associated record” icon to find the record with the same card serial number of the card you just scanned with the card reader.
6. Click on the “Encode” button to encode the card with the CCI-file connected to the card design linked to the record or on the “Erase” to delete the current information encoded on the card.
7. With a new card, that does not have an associated record, click on the “Link to selected record” to link the card to the record. The card serial number will be written to the Card Serial Number column in the project.

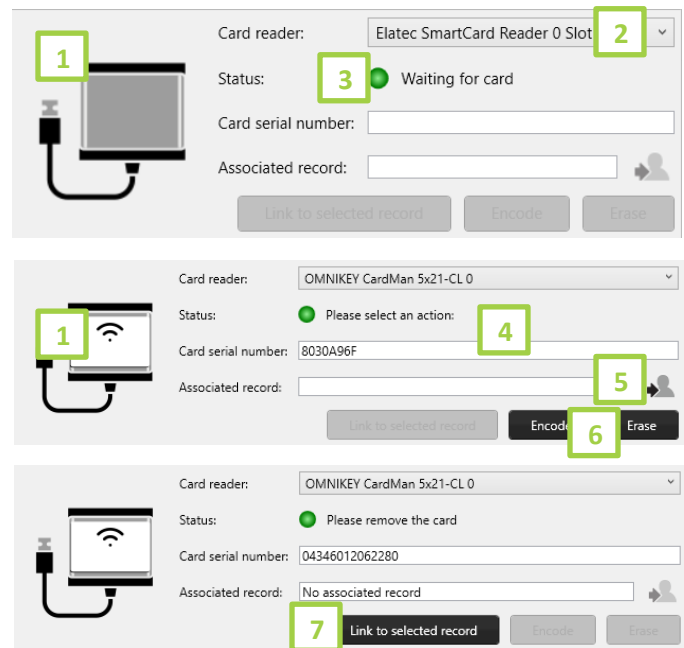

 badgemaker  
**CONNECT**  
**USER GUIDE ADD-ONS**

**BADGEMAKER CONNECT**

October 2024

User Guide V2.11.12

BadgeMaker Connect V2.11.12

## BADGEMAKER CONNECT

The BadgeMaker Connect Add-on allows users to connect with external databases and use the data to complement their local project, or even base the entire project upon it. There are four types of databases supported:

- Microsoft SQL Server
- Microsoft Access files
- MySQL Server
- Oracle Server

Choosing from one of these four settings is highly recommended, however it is also possible to connect to a database through an ODBC driver. **NOTE: We no longer provide support for ODBC. Existing projects will continue to work, but the option to create new projects with an ODBC connection may be removed in the future. Use at your own discretion.**

Connecting with one of the supported databases allows you to make full use of the database's functionality. For example: BadgeMaker will automatically lock tables when adding or updating records, it will automatically detect user rights and allows you to work with views.

Connecting with a data source through an ODBC driver proves you with more basic functionality, but it will suffice for most single-user environments. BadgeMaker Connect will automatically detect any available ODBC drivers on the system, if the required ODBC driver is not listed, it can be installed using the Microsoft update website or tool in your operating system. Note: BadgeMaker Connect does not create an external database for you, it only creates a connection to an existing external database.

This screenshot shows the Project settings dialog, where the option for BadgeMaker Connect will be present depending on your license key.

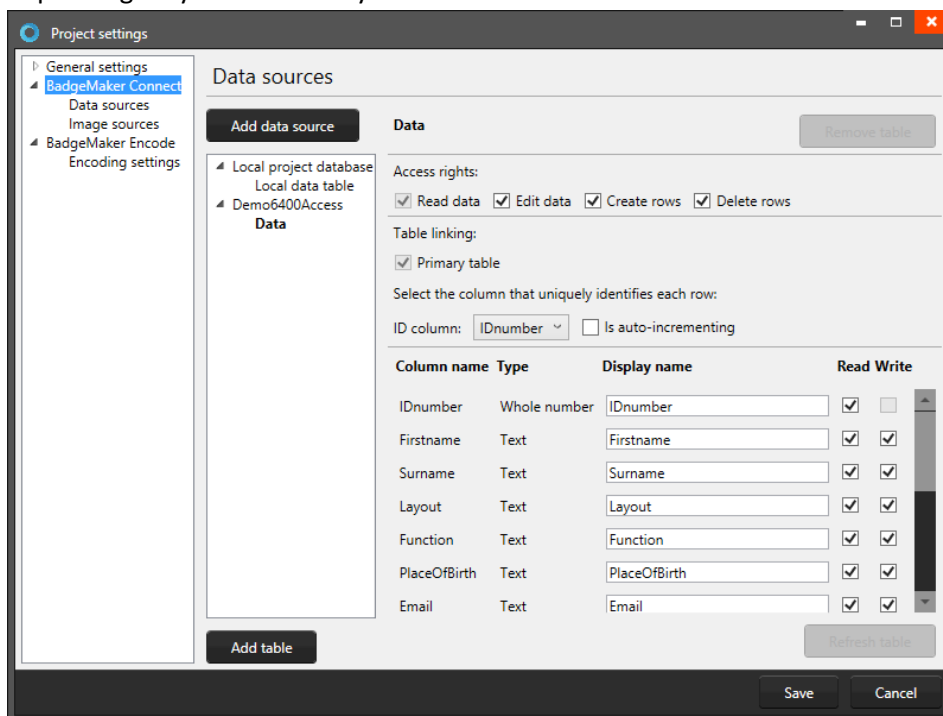

## Setting up BadgeMaker Connect

### 1.1. How to set up a BadgeMaker Connect Project

Follow these steps if you want to create a project using an external data source as your primary source of information. If you want the local BadgeMaker Identity project to be your primary source of information, please refer to chapter 2.

We will start by creating a new project. Click the New Project icon and select “**Create a new BM CONNECT project**” from the dialog.

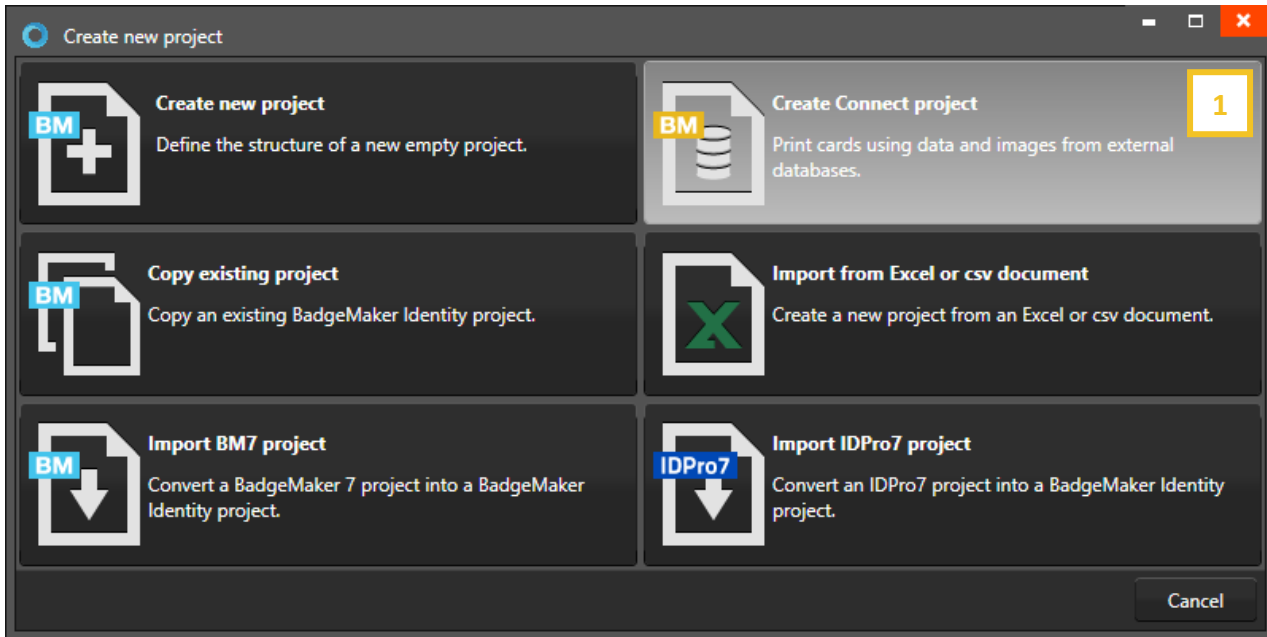

Fig. Example of a new project pop-up window: select Create Connect project.



## Step 1: Connect database

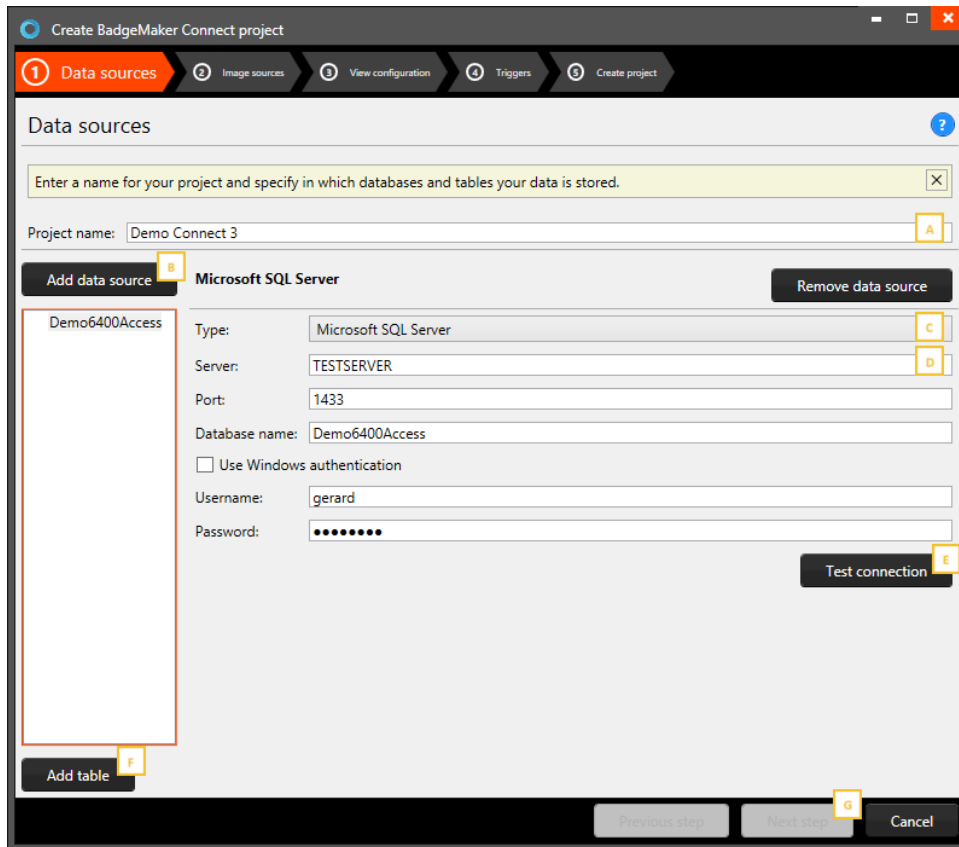

Fig. Example of a new Connect project with external database connection step 1: data sources.

- A. Enter the name of your BadgeMaker Connect project.
- B. Click on the “Add data source” to connect the database with your external database.

C. Select the type of database you would like to connect with.

Different types of databases are being supported:

### 1 Configuring a Microsoft SQL Server data source

After selecting Microsoft SQL Server as the type of data source, you can fill in all information required to connect to the server.

- D. Server: Path or IP address to the server. If the server is hosted on another system in the network, it can be either addressed as \\servername or the IP address of the server. Information such as the database name, username and password will be provided by your database administrator. Note that in order to be able to work with a Microsoft SQL Server, an active network connection must be available.

### 2 Configuring a Microsoft Access data source

To define a Microsoft Access data source, select the option from the drop-down list, and find the path to your database by choosing the Browse (“...”) button behind the Filename field. Please note that a username and password may not be required for your Microsoft Access file, in which case these fields can be left empty.

### 3 Configuring an Oracle data source

Configuring an Oracle server as a data source is done in the same fashion as defining a Microsoft SQL Server data source.

**4 Configuring a data source through an ODBC driver**

After selecting ODBC as the type of data source, you will be able to select one of the ODBC drivers installed on your system. Please note that Windows may have more than one driver installed per file extension.

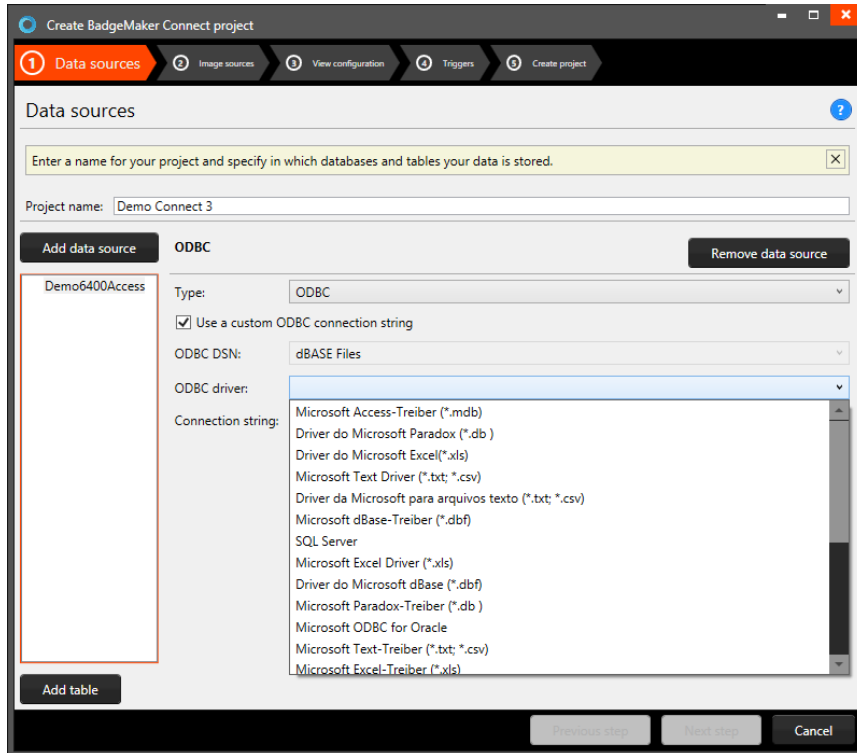

After selecting the driver, you can provide a direct path to your database file. This can be a local path (C:\Example\Example.mdb) or a remote path (\\Server\Example\Example.mdb). Note that to be able to open your project using a remote directory, an active network connection must be available.

- E. After configuring the data source, click the button **“Test connection”**. Once the dialogue reports **“Connection OK!”** you can proceed. If the connection cannot be established, the dialogue will report a detailed overview of the problem. Check all information and make sure a connection with the external server is available before trying again.



- F. Once the connection is established, click **“Add table”** to continue configuring your data source. A pop-up dialogue will all tables available to you.

Microsoft SQL Server will likely only list database tables, where other files (such as MS Access databases) might also tables otherwise invisible to the user.

After selecting a table, you can configure the rights to the table, and to each of the listed columns in the table. Users

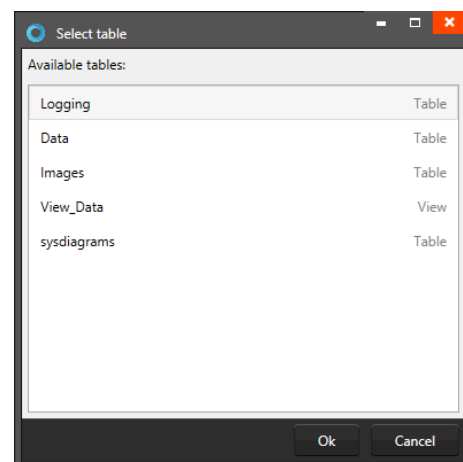

list

list

connecting with a Microsoft SQL Server will also be able to create and remove rows, whereas users connecting through an ODBC database will only be able to select the “**Edit data**” checkbox for existing rows.

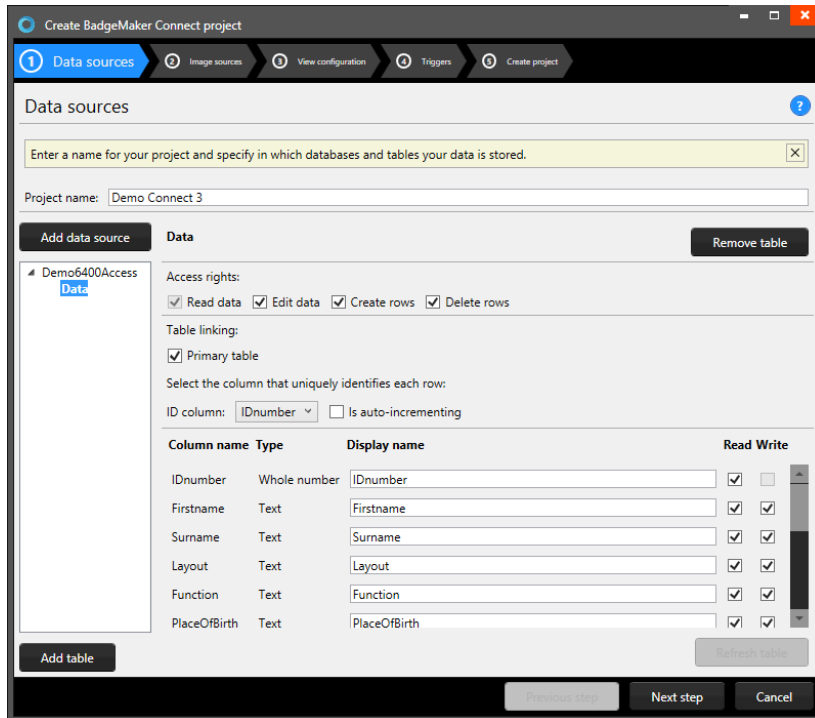

Note that the newly created data source will have the “**Primary table**” checkbox checked. This setting can only be altered during the process of defining the data sources, so make sure that the primary table is correctly configured.

For a primary table, you can define the “**Id column**” this is a column containing unique, numeric data. For secondary tables, you must define its relation to the primary table or to one of the tables linked to the primary table. This means that each table will have to contain a column containing a corresponding type and kind of data. It is advised to keep the column marked

as “**Id column**” as read-only or even hidden if the data in the column is not crucial to users working with the data grid.

The list of columns can be used to define certain restrictions to each column such as “**Read-only**” or “**Hidden**”. By default, columns will be marked as “**Read-only**”. Consider carefully what data you want to manage through BadgeMaker, and what data should be managed by other external systems.

G. Click on the “**Next step**”, finish the next steps and create the project. With the second step you can define the image sources for passport photos and signatures in your project. You can choose from three different options:

- **Read image from local project**  
Selecting this option stores captured images along with the BadgeMaker Identity project files. This option can be used to capture new image data.
- **Read or download image from path or URL**  
This option allows you to read images from a remote directory either on a server or on a network drive. This can only be used to *read* image data. New data cannot be captured.
- **Read image from database (blob)**  
This allows you to read an image from a specific column in the databased marked as BLOB (**B**inary **L**arge **O**bject) This option can be used to both read existing data and capture new image data to the database.

## Changes when working with BadgeMaker Connect

There are a couple of changes that may be noticeable when working with BadgeMaker Connect in comparison to regular BadgeMaker Identity projects.

### **Loading times**

The time it takes to load your project, or to process changes to your database may increase. This is due to the time it takes to transfer data over the network, login to the database or retrieve data from the external data sources.

### **Grayed-out columns**

Columns that have been marked as “read only” will have a grey background color when selected. It simply means that you will not be able to alter data for that specific column.

### **Data binding looks different**

When working with multiple data sources, it can become confusing to remember what information belongs to what data source. In order to clarify, BadgeMaker will label sources with `<table_name>.<column_name>`. This means that a column “Firstname” coming from a table called “Students” will be displayed as “Students.Firstname” when binding data.

### **Updating or adding pictures**

Depending on the read or write access restrictions and the configuration of image sources in your project, you may or may not be able to add new images.

### **Project has stopped working**

BadgeMaker cannot prevent external data sources from changing. If a file gets removed, or a database gets changed, it might cause your BadgeMaker Identity project to stop working. Always consult with your database administrator to ensure that data you need in your BadgeMaker Project is made redundantly available to you.

### **Default values**

When creating a new project, or when altering a project structure, you can define certain default values for your column types. However, when using BadgeMaker Connect, these default values will only be filled for new records or when manually entering the information into the field. The reason for this is because the local project data does not contain the same amount of records as the external sources, and new records are never created automatically.



# USER GUIDE ADD-ONS

## BADGEMAKER SHARE

October 2024

User Guide V2.11.12

BadgeMaker Share V2.11.12

## BADGEMAKER SHARE

BadgeMaker Share is an Add-on for BadgeMaker Base and BadgeMaker Pro licenses. It allows users to turn their BadgeMaker installation into a Server – Client system that allows multiple users to collaborate on projects simultaneously.

### BadgeMaker Share Server

BadgeMaker Share Server is the latest addition to BadgeMaker and appears as standard in each installation procedure starting from version 2.0.0 and greater. Note that while BadgeMaker Share Server may be installed along with BadgeMaker Identity and BadgeMaker Design, it will only function if your license grants you access to the Add-on.

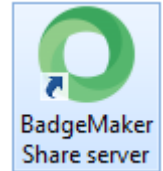

### BadgeMaker Share Client

In addition to the BadgeMaker Share Server, the BadgeMaker Share Client is introduced as a separate license that allows for cost-effective use of BadgeMaker in larger organizations. BadgeMaker Share Client looks and functions like BadgeMaker Identity, but it is required to connect to a BadgeMaker Share Server in order to function.

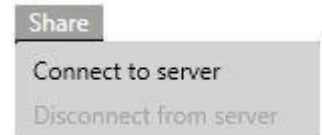

## Installation

Installation of BadgeMaker Share takes place in a couple of steps. We identify them as follows:

### 1 Selecting a server computer

Before starting the installation procedure, it is important to select a computer system that is designated the exclusive task of running BadgeMaker Share Server. The system should comply with the following requirements:

- Running Windows 7 Professional or greater.
- An Intel Core i5 or Core i7 processor running at 2.0 Ghz or greater.
- A minimum of 4GB RAM, 8GB RAM is recommended.
- A 7200 RPM hard drive. Using a Solid-State Drive is recommended. The available space depends on your project requirements.
- A permanent 100 Mbit Ethernet connection (Wired) to other systems in the network.
- A user profile with full administrative rights on the system.

Please note: Deviating from the minimum system requirements will severely impact the user experience when connecting to the BadgeMaker Share Server.

### 2 Installation and configuration of BadgeMaker Share Server

Once the appropriate server computer is selected, you can start with the installation of BadgeMaker Share Server. Download the BadgeMaker installer file from [badgemaker.info](http://badgemaker.info) or use your login credentials in the License Manager to retrieve the installation files.

Please note: The installation procedure is performed like regular installations. Please refer to the corresponding chapter for more information on installing BadgeMaker.

During installation, it is important to check the box for BadgeMaker Share Server, as well as BadgeMaker Identity and BadgeMaker Design. Once completed, click the icons placed on the desktop during installation, or navigate to the installation directory, and find the folder titled "Server". This folder contains all the files needed to run BadgeMaker Share Server.

Start the application "BadgeMakerServerUI.exe" with administration rights using Right Click and select "Run as administrator". You will be prompted with the license screen, where your BadgeMaker Base or Pro license that features the BadgeMaker Share Add-on can be entered. Once completed, the user interface for the BadgeMaker Share Server will launch.

Please note: You may be prompted to create an exception for BadgeMaker Share Server to your firewall. It is important to allow for this step, since client systems will be unable to connect to the server if the exception is neglected.

### 3 Configuration

Once the installation procedure is completed, it is time to configure your BadgeMaker Share Server. The first step is to configure the IP address and port on which client systems will be able to connect.

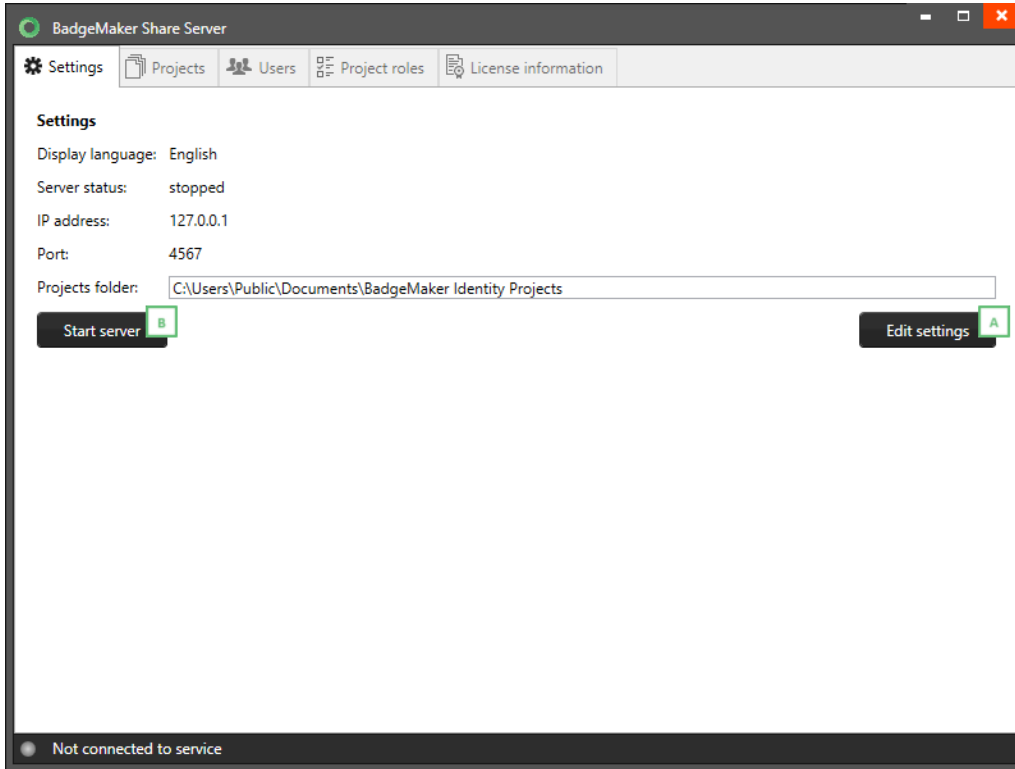

#### A. Edit settings

It is important to add the local IP address that can be used by client systems to connect to the network. Please make sure that your system is discoverable on the Local Area Network as well.

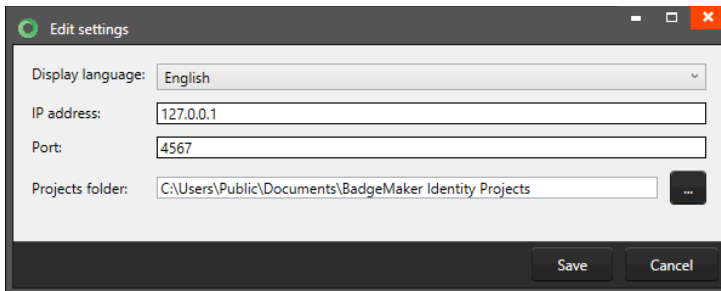

#### B. Start server

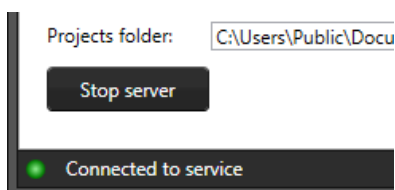

When the correct Language, IP address, Port and Project folder location are chosen, click on the “Start Server” button to start the server. You will see little circle light up to a green color to indicate the service is connected.



## 3.4 Project roles

The next step is to configure Project roles that match the requirement of your organization. By default, certain roles are entered as an example. It is possible to create a new project role by clicking “[Create new project role](#)”.

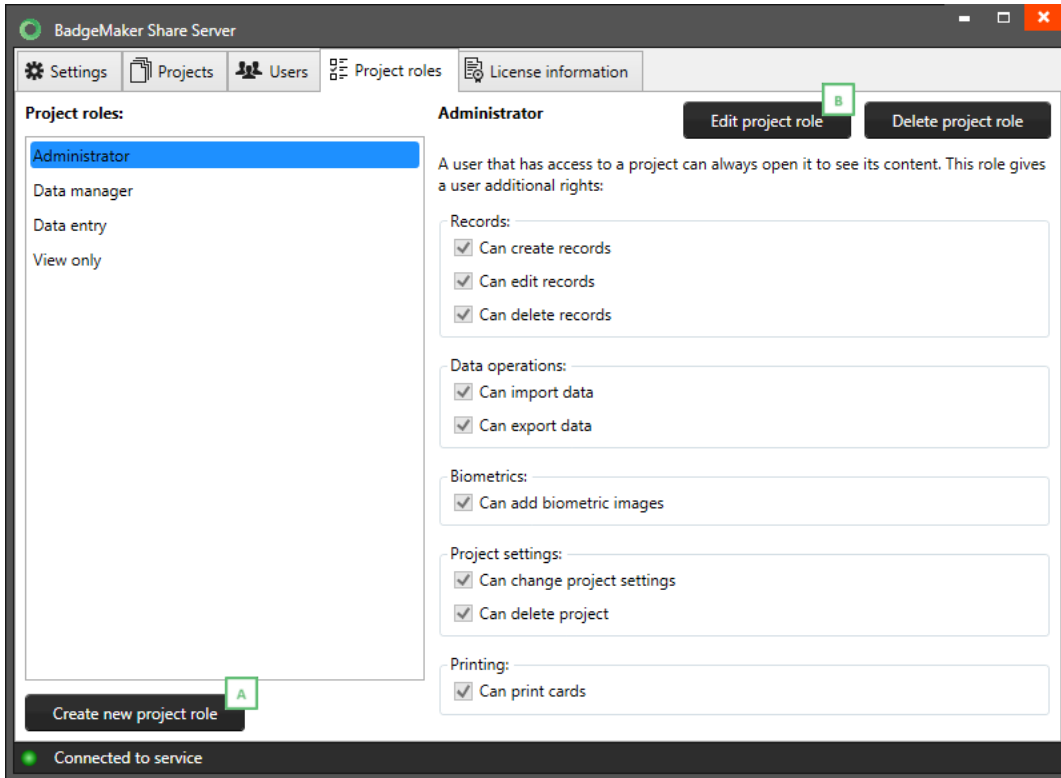

### A. Create a new project role

Rename the new role. The following functions for a role can be turned on or off by clicking the checkboxes on the screen:

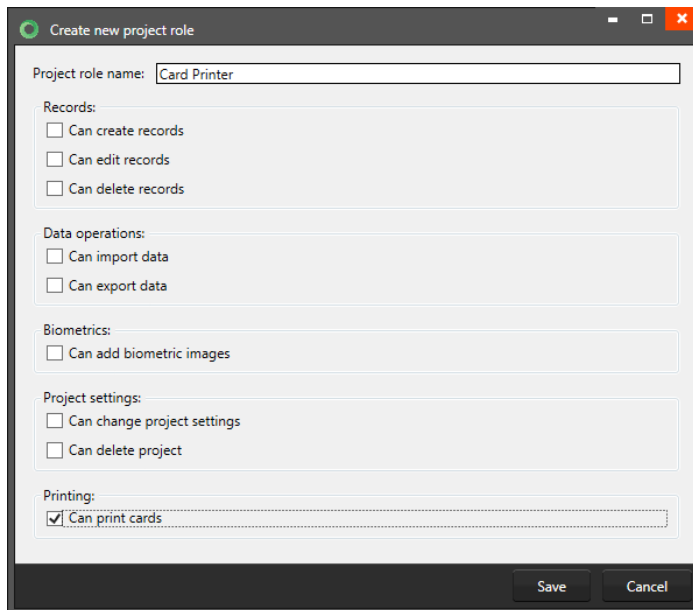

### B. Edit or Delete a project role

You can select an existing role and adjust or delete them by clicking on these buttons.

## 5 Users

Once project roles have been set, it is time to create accounts for users who should be able to connect to a project. If you are running a clean installation of BadgeMaker on your server, it is likely that no projects are present on the system. In which case, it is recommended to create a single user with the rights to create projects on the server, before creating new user accounts.

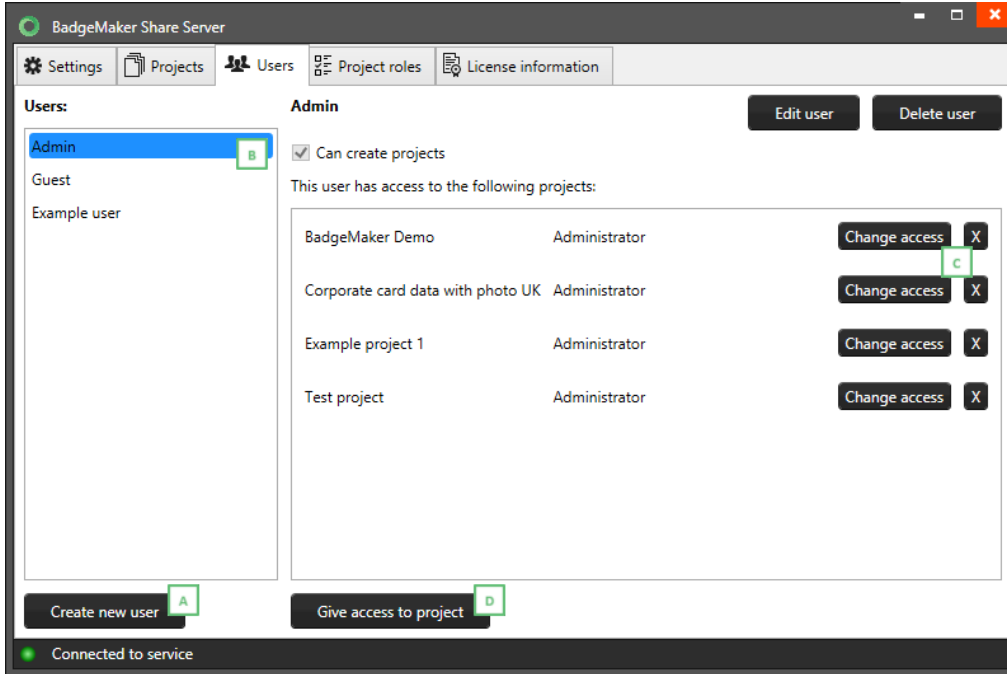

### A. Creating user accounts

Navigate to the Users tab in BadgeMaker Share Server and click on “Create new user”.

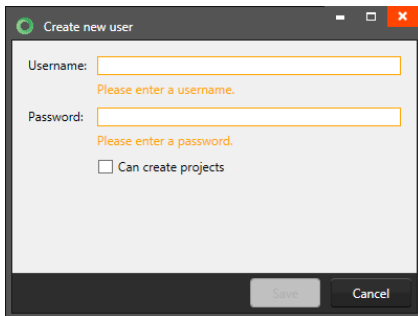

Enter a username and password in the fields and check the “Can create projects” checkbox if the user needs to have administrative rights to create projects on the BadgeMaker Share Server.

### B. Give or change access

The newly created account will appear in the list above the input fields and can be selected in order to inspect which projects the user has been granted access to, change access or give access to a new project.

### C. Edit or Delete a project role

You can select an existing role and adjust or delete them by clicking on these buttons.

### D. Grant access to project

Select a specific user and give the user access to a project by clicking on “Give access to project”, selecting the project and the role from the drop-down menus.

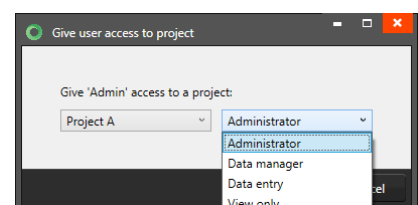

## 6 Projects

Once roles have been created, and user accounts have been set up, you can navigate to the “Projects” tab to find out that no projects have been registered on your system. Because of this, we will create a new project first, before finalizing the configuration of BadgeMaker Share Server.

Launch BadgeMaker Identity on the server computer, or on a client system if so desired. Enter the license information, and perform the following actions:

- Click “Share” in the toolbar and select “Connect to server”.
- Enter the username and password of a user that has the rights to create projects.
- Click the Show Server Settings button.
- Enter the Local Area Network IP address that was entered during the previous steps.
- Enter the Port address that was entered during the previous steps.
- Click “Log in” to connect to the server.

If you performed all steps correctly, you should be able to see a connection status image turn to green in the lower right corner of your window. You may always refer to this image to check if you are still connected to the server.

- Click “File” in the toolbar and select “Create new share project”.
- Follow the project creation wizard. Once completed, the project will appear in the Projects tab on your BadgeMaker Share Server.

Please note: If you have previously installed BadgeMaker on your server computer, you may see projects appear in the list. If this is the case, you can skip this step, and continue to assign users to projects.

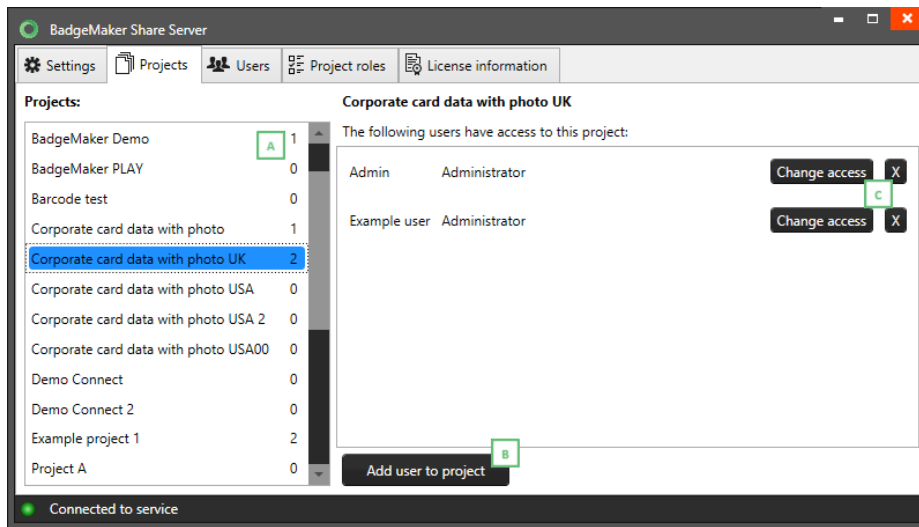

### A. Assigning projects

Once a project is created, it is possible to assign user accounts to a project. Select the Projects tab on your BadgeMaker Share Server and select the project you wish to assign users to.

### B. Add user to project

Select the user account you wish to add, as well as the role you wish to assign to the user for this specific project. Click “Save” to complete the procedure.

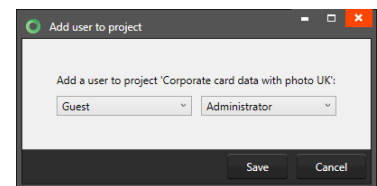

### C. Edit or Delete a project role

You can select an existing user and adjust or delete them by clicking on these buttons.

Users may be added to several project, each time with a different role. If a role is updated or altered, it will be automatically reflected for users once they establish a connection with the BadgeMaker Share server.

## 7 Installation and configuration of BadgeMaker Share Client

For client systems, installation is performed just like a stand-alone installation of BadgeMaker. Follow the corresponding chapter for more details on the installation procedure. Once completed, you may launch BadgeMaker Identity by clicking the icon that was placed on the Desktop during the installation procedure or navigate to the installation directory and start BadgeMaker Identity manually.

During first start-up, you will be prompted to enter your license. This is where you enter the license key that is intended for the client machines connecting to the BadgeMaker Share Server. If you have been issued an “**Online License**”, you will be able to use the same key on the number of client systems that was indicated in your order.

Once activated, you can connect BadgeMaker Identity to the BadgeMaker Share Server: Click “**Share**” in the toolbar and select “**Connect to server**”.

- Enter the username and password of a registered user account.
- Click the Show Server Settings button.
- Enter the Local Area Network IP address of the BadgeMaker Share Server.
- Enter the Port address of the BadgeMaker Share Server.
- Click “Log in” to connect to the server.

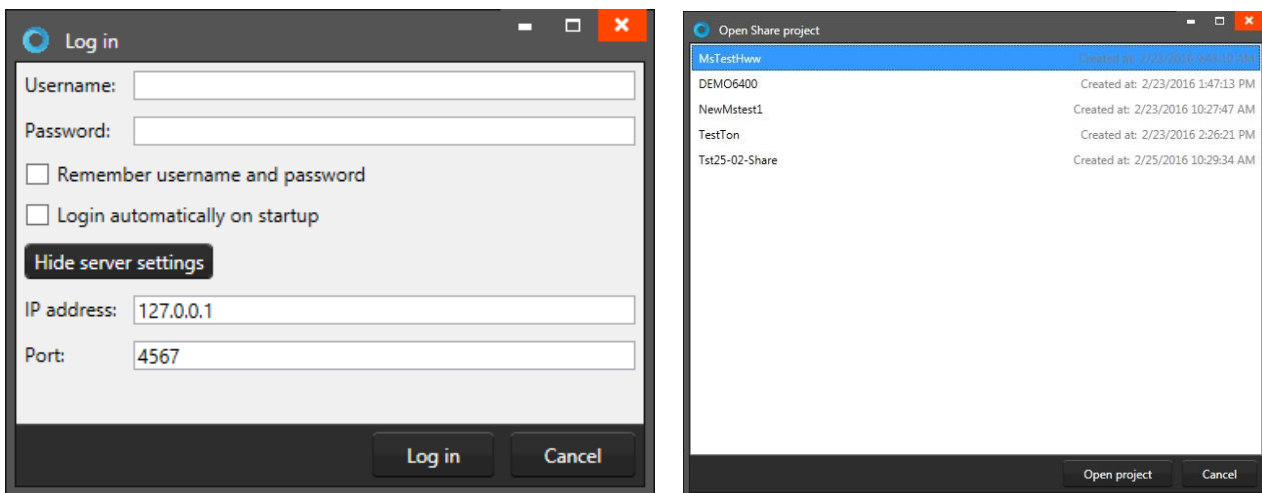

Example of the log in window to the Share Server as a Client and open a shared project.

If you performed all steps correctly, you should be able to see a connection status image turn to green in the lower right corner of your window. You may always refer to this image to check if you are still connected to the server.

Note: BadgeMaker Share Client behaves slightly different from BadgeMaker Identity. Here is a list of things to keep in mind when using BadgeMaker Share Client:

- BadgeMaker Share Client will “**inherit**” all features and rights from BadgeMaker Share Server. If a button is disabled, or if you are unable to perform an action, it is likely that your account does not have permission to perform that action.
- Data will only be processed when the connection is active. Keep an eye on the connection indicator button if you feel that your information is not processed. Your connection to the BadgeMaker Share Server might be poor.
- Uploading data might take time. If you are attaching a large file (a photo for instance) to a record, it might take longer than usual to process these changes. This is because all information must be sent to the BadgeMaker Share Server first before it is reflected on all other client systems.

## Disclaimer

Copyright ScreenCheck B.V.

The user guide is subject to change without notice.

The BadgeMaker User Guide (the “Manual”) is proprietary to ScreenCheck B.V. (“SC”) and no ownership rights are hereby transferred. No part of the Manual shall be used, reproduced, translated, converted, adapted, stored in a retrieval system, communicated or transmitted by any means, for any commercial purpose, including without limitation, sale, resale, license, rental or lease, without the prior express written consent of SC.

SC does not make any representations, warranties or guarantees, express or implied, as to the accuracy or completeness of the Manual. Users must be aware that updates and amendments will be made from time to time to the Manual. It is the user’s responsibility to determine whether there have been any such updates or amendments. Neither SC nor any of its directors, officers, employees or agents shall be liable in contract, tort or in any other manner whatsoever to any person for any loss, damage, injury, liability, cost or expense of any nature, including without limitation incidental, special, direct or consequential damages arising out of or in connection with the use of the Manual.

### User Guide Log

User Guide Version:	BadgeMaker Version	Date:	Changes:
V2.0	V2.0	21-03-16	Adjusted all screenshots for Identity 2.0 and added Share Add-On
V2.0.4	V2.0.4	01-04-16	Small adjustments and update of the printer overview
V2.0.35	V2.0.35	01-09-16	Added the extra biometrics step and updated BadgeMaker Encode and Connect Chapters.
V2.1.9	V2.1.9	03-05-17	Updated the photo, print view and the BadgeMaker Share Chapter.
<b>V2.5.0</b>	V2.5.0	23-09-18	Adjusted all screenshots for BadgeMaker 2.5.5. and general update.
<b>V2.6.0</b>	V2.6.0	31-01-19	Adjusted all screenshots for BadgeMaker 2.6.2 and general update.
<b>V2.6.5</b>	V2.6.5	29-04-19	Adjusted all screenshots for BadgeMaker 2.6.5 and general update.
<b>V2.7</b>	V2.7	16-09-2019	Added BadgeMaker Store. Adjusted all screenshots for BadgeMaker 2.7 and general update.
<b>V2.8</b>	V2.8	20-01-2021	Added BadgeMaker Store to Identity. Adjusted all screenshots needed for BadgeMaker 2.8 and general update.
<b>V2.9</b>	V2.9	03-03-2022	Added gradient to BadgeMaker Design, adjusted all screenshots for BadgeMaker 2.9, updated encoding, added stand-alone encoding and general updates
<b>V2.10</b>	V2.10	12-14-2022	Added adjustment to UI for BadgeMaker Identity card design overview, adjustment Connect support ODBC, Updated supported printers.
<b>V2.11</b>	V2.11	07-19-2023	Added adjustment to Signature tool and new record functionality.
<b>V2.11.9</b>	V2.11.9	01-07-2024	Add adjustments to printerlist, XML import, Encoding date adjustment
<b>V2.11.12</b>	V2.11.12	16-10-2024	Add adjustments to PrintStudio menu, Project settings and added NDEF data format to Encode